

Universal Digital Alarm
Communicator/Transmitter
UDACT-F

Instruction Manual

Fire Alarm System Limitations

An automatic fire alarm system—typically made up of smoke detectors, heat detectors, manual pull stations, audible warning devices, and a fire alarm control with remote notification capability—can provide early warning of a developing fire. Such a system, however, does not assure protection against property damage or loss of life resulting from a fire.

The Manufacturer recommends that smoke and/or heat detectors be located throughout a protected premise following the recommendations of the current edition of the National Fire Protection Association Standard 72 (NFPA 72), manufacturer's recommendations, State and local codes, and the recommendations contained in the Guide for Proper Use of System Smoke Detectors, which is made available at no charge to all installing dealers. A study by the Federal Emergency Management Agency (an agency of the United States government) indicated that smoke detectors may not go off in as many as 35% of all fires. While fire alarm systems are designed to provide early warning against fire, they do not guarantee warning or protection against fire. A fire alarm system may not provide timely or adequate warning, or simply may not function, for a variety of reasons:

Smoke detectors may not sense fire where smoke cannot reach the detectors such as in chimneys, in or behind walls, on roofs, or on the other side of closed doors. Smoke detectors also may not sense a fire on another level or floor of a building. A second-floor detector, for example, may not sense a first-floor or basement fire.

Particles of combustion or "smoke" from a developing fire may not reach the sensing chambers of smoke detectors because:

- Barriers such as closed or partially closed doors, walls, or chimneys may inhibit particle or smoke flow.
- Smoke particles may become "cold," stratify, and not reach the ceiling or upper walls where detectors are located.
- Smoke particles may be blown away from detectors by air outlets.
- Smoke detectors may be drawn into air returns before reaching the detector.

The amount of "smoke" present may be insufficient to alarm smoke detectors. Smoke detectors are designed to alarm at various levels of smoke density. If such density levels are not created by a developing fire at the location of detectors, the detectors will not go into alarm.

Smoke detectors, even when working properly, have sensing limitations. Detectors that have photoelectronic sensing chambers tend to detect smoldering fires better than flaming fires, which have little visible smoke. Detectors that have ionizing-type sensing chambers tend to detect fast-flaming fires better than smoldering fires. Because fires develop in different ways and are often unpredictable in their growth, neither type of detector is necessarily best and a given type of detector may not provide adequate warning of a fire.

Smoke detectors cannot be expected to provide adequate warning of fires caused by arson, children playing with matches (especially in bedrooms), smoking in bed, and violent explosions (caused by escaping gas, improper storage of flammable materials, etc.).

While a fire alarm system may lower insurance rates, it is not a substitute for fire insurance!

Heat detectors do not sense particles of combustion and alarm only when heat on their sensors increases at a predetermined rate or reaches a predetermined level. Rate-of-rise heat detectors may be subject to reduced sensitivity over time. For this reason, the rate-of-rise feature of each detector should be tested at least once per year by a qualified fire protection specialist. *Heat detectors are designed to protect property, not life.*

IMPORTANT! Smoke detectors must be installed in the same room as the control panel and in rooms used by the system for the connection of alarm transmission wiring, communications, signaling, and/or power. If detectors are not so located, a developing fire may damage the alarm system, crippling its ability to report a fire.

Audible warning devices such as bells may not alert people if these devices are located on the other side of closed or partly open doors or are located on another floor of a building. Any warning device may fail to alert people with a disability or those who have recently consumed drugs, alcohol or medication. Please note that:

- Strobes can, under certain circumstances, cause seizures in people with conditions such as epilepsy.
- Studies have shown that certain people, even when they hear a fire alarm signal, do not respond or comprehend the meaning of the signal. It is the property owner's responsibility to conduct fire drills and other training exercise to make people aware of fire alarm signals and instruct them on the proper reaction to alarm signals.
- In rare instances, the sounding of a warning device can cause temporary or permanent hearing loss.

A fire alarm system will not operate without any electrical power. If AC power fails, the system will operate from standby batteries only for a specified time and only if the batteries have been properly maintained and replaced regularly.

Equipment used in the system may not be technically compatible with the control. It is essential to use only equipment listed for service with your control panel.

Telephone lines needed to transmit alarm signals from a premise to a central monitoring station may be out of service or temporarily disabled. For added protection against telephone line failure, backup radio transmission systems are recommended.

The most common cause of fire alarm malfunction is inadequate maintenance. To keep the entire fire alarm system in excellent working order, ongoing maintenance is required per the manufacturer's recommendations, and UL and NFPA standards. At a minimum, the requirements of Chapter 7 of NFPA 72 shall be followed. Environments with large amounts of dust, dirt or high air velocity require more frequent maintenance. A maintenance agreement should be arranged through the local manufacturer's representative. Maintenance should be scheduled monthly or as required by National and/or local fire codes and should be performed by authorized professional fire alarm installers only. Adequate written records of all inspections should be kept.

Installation Precautions

WARNING - Several different sources of power can be connected to the fire alarm control panel. Disconnect all sources of power before servicing. Control unit and associated equipment may be damaged by removing and/or inserting cards, modules, or interconnecting cables while the unit is energized. Do not attempt to install, service, or operate this unit until this manual is read and understood.

CAUTION - *System Reacceptance Test after Software Changes.* To ensure proper system operation, this product must be tested in accordance with NFPA 72 Chapter 7 after any programming operation or change in site-specific software. Reacceptance testing is required after any change, addition or deletion of system components, or after any modification, repair or adjustment to system hardware or wiring.

All components, circuits, system operations, or software functions known to be affected by a change must be 100% tested. In addition, to ensure that other operations are not inadvertently affected, at least 10% of initiating devices that are not directly affected by the change, up to a maximum of 50 devices, must also be tested and proper system operation verified.

This system meets NFPA requirements for operation at 0-49° C/32-120° F and at a relative humidity of 85% RH (non-condensing) at 30° C/86° F. However, the useful life of the system's standby batteries and the electronic components may be adversely affected by extreme temperature ranges and humidity. Therefore, it is recommended that this system and all peripherals be installed in an environment with a nominal room temperature of 15-27° C/60-80° F.

Verify that wire sizes are adequate for all initiating and indicating device loops. Most devices cannot tolerate more than a 10% I.R. drop from the specified device voltage.

Adherence to the following will aid in problem-free installation with long-term reliability:

Like all solid state electronic devices, this system may operate erratically or can be damaged when subjected to lightning-induced transients. Although no system is completely immune from lightning transients and interferences, proper grounding will reduce susceptibility. *Overhead or outside aerial wiring is not recommended, due to an increased susceptibility to nearby lightning strikes.* Consult with the Technical Services Department if any problems are anticipated or encountered.

Disconnect AC power and batteries prior to removing or inserting circuit boards. Failure to do so can damage circuits.

Remove all electronic assemblies prior to any drilling, filing, reaming, or punching of the enclosure. When possible, make all cable entries from the sides or rear. Before making modifications, verify that they will not interfere with battery, transformer, and printed circuit board location.

Do not tighten screw terminals more than 9 in-lbs. Over-tightening may damage threads, resulting in reduced terminal contact pressure and difficulty with screw terminal removal.

Though designed to last many years, system components can fail at any time. This system contains static-sensitive components. Always ground yourself with a proper wrist strap before handling any circuits so that static charges are removed from the body. Use static-suppressive packaging to protect electronic assemblies removed from the unit.

Follow the instructions in the installation, operating, and programming manuals. These instructions must be followed to avoid damage to the control panel and associated equipment. FACP operation and reliability depend upon proper installation by authorized personnel.

FCC Warning

WARNING: This equipment generates, uses, and can radiate radio frequency energy and if not installed and used in accordance with the instruction manual, may cause interference to radio communications. It has been tested and found to comply with the limits for class A computing device pursuant to Subpart B of Part 15 of FCC Rules, which is designed to provide reasonable protection against such interference when operated in a commercial environment. Operation of this equipment in a residential area is likely to cause interference, in which case the user will be required to correct the interference at his own expense.

Canadian Requirements

This digital apparatus does not exceed the Class A limits for radiation noise emissions from digital apparatus set out in the Radio Interference Regulations of the Canadian Department of Communications.

Le présent appareil numérique n'émet pas de bruits radioélectriques dépassant les limites applicables aux appareils numériques de la classe A prescrites dans le Règlement sur le brouillage radioélectrique édicté par le ministère des Communications du Canada.

This digital communicator has been designed to comply with standards set forth by the following regulatory agencies:

- Underwriters Laboratories Standard UL 864
- NFPA 72 National Fire Alarm Code
- CAN/ULC - S527M Standard for Control Units for Fire Alarm Systems

Before proceeding, the installer should be familiar with the following documents.



NFPA Standards

This digital communicator complies with the following NFPA Standards:

NFPA 72 National Fire Alarm Code for Central Station Signaling Systems Protected Premises Unit (Automatic, Manual and Waterflow), Local Fire Alarm Systems (Automatic, Manual, Waterflow and Sprinkler Supervisory), Proprietary Fire Alarm Systems (Protected Premises Unit), Automatic Fire Detectors, Installation, Maintenance and Use of Notification Appliances for Fire Alarm Systems and Inspection, Testing and Maintenance for Fire Alarm Systems.



FM Approved (with Ademco 685 Receiver)



Underwriters Laboratories Documents:

UL 38 Manually Actuated Signaling Boxes
UL 217 Smoke Detectors, Single and Multiple Station
UL 228 Door Closers–Holders for Fire Protective Signaling Systems
UL 268 Smoke Detectors for Fire Protective Signaling Systems
UL 268A Smoke Detectors for Duct Applications
UL 346 Waterflow Indicators for Fire Protective Signaling Systems
UL 464 Audible Signaling Appliances
UL 521 Heat Detectors for Fire Protective Signaling Systems
UL 864 Standard for Control Units for Fire Protective Signaling Systems
UL 1481 Power Supplies for Fire Protective Signaling Systems
UL 1638 Visual Signaling Appliances
UL 1971 Signaling Devices for Hearing Impaired
CAN/ULC - S524M Standard for Installation of Fire Alarm Systems



Other:

NEC Article 250 Grounding
NEC Article 300 Wiring Methods
NEC Article 760 Fire Protective Signaling Systems
Applicable Local and State Building Codes
C22.1, Canadian Electrical Code, Part I
C22.2 No. 0, General Requirements - Canadian Electrical Code, Part II
C22.2 No. 0.4, Bonding and Grounding of Electrical Equipment (Protective Grounding) - Canadian
C282, Emergency Electrical Power Supply for Buildings - Canadian
Requirements of the Local Authority Having Jurisdiction (LAHJ)

Fire•Lite Documents

Fire•Lite Device Compatibility Document Document #15384

Table of Contents

CHAPTER 1: Product Description	7
1.1: Product Features	7
FIGURE 1-1: UDACT-F Assembly	8
1.2: Controls and Indicators	9
FIGURE 1-2: Controls and Indicators	9
1.3: Compatible Panels	9
1.4: Digital Communicator	9
1.5: Circuits	10
1.5.1: Power Requirements	10
1.5.2: Communications	10
1.5.3: Primary and Secondary Phone Lines	10
1.5.4: Communicator Fail Relay Driver	10
1.5.5: Earth Ground	10
1.6: Specifications	10
1.7: Telephone Requirements and Warnings	11
1.7.1: Telephone Circuitry - PH1 & PH2	11
1.7.2: Digital Communicator	11
1.7.3: Telephone Company Rights and Warnings:	11
1.7.4: For Canadian Applications	12
1.8: Modes and Special Functions	13
1.8.1: Normal Mode	13
1.8.2: Program Mode	13
1.8.3: Lamp Test Mode	13
1.8.4: Troubleshoot Mode	13
1.8.5: Type Mode	13
1.8.6: Clear Function	13
1.8.7: Manual Test Function	13
CHAPTER 2: Installation	14
2.1: Mounting Options	14
FIGURE 2-1: ABS-8RF	14
2.2: Panel Mounting	14
2.2.1: MS-9200	14
FIGURE 2-2: UDACT-F Mounting to MS-9200	14
FIGURE 2-3: External UDACT-F Mounting in ABS-8RF - MS-9200	15
TABLE 2-1: Annunciator LED Assignments (MS-9200)	16
2.2.2: MS-9600	17
FIGURE 2-4: UDACT-F Wiring to MS-9600	17
TABLE 2-2: Annunciator LED Assignments (MS-9600)	18
2.2.3: Sensiscan 2000	19
FIGURE 2-5: UDACT-F Mounting in CHS-4	19
FIGURE 2-6: EIA-485 Connection Sensiscan 2000	20
FIGURE 2-7: 24 VDC Power Connection to UDACT-F	21
TABLE 2-3: Sensiscan 2000 Annunciator LED Assignments	22
2.3: UL Power-limited Wiring Requirements	23
FIGURE 2-8: Typical Wiring Diagram for UL Power-limited Requirements	23
2.4: Output Circuits	24
2.4.1: Telephone Circuits	24
FIGURE 2-9: Wiring Phone Jacks	24
2.4.2: Relay Driver	25
FIGURE 2-10: Relay Driver Connections	25
FIGURE 2-11: Monitoring for UDACT-F Trouble	26

CHAPTER 3: Programming Instructions	27
3.1: Entering Program Mode	27
3.2: Switch (Key) Functions	28
FIGURE 3-1: UDACT-F Keypad	28
3.3: Programming Options	28
TABLE 3-1: Start and End Monitoring Address	31
TABLE 3-2: Primary Number Event Codes - 3+1, 4+1 Express and 4+1 Standard	34
TABLE 3-3: Primary Number Event Codes - 4+2 Standard and 4+2 Express	35
TABLE 3-4: Ademco Contact ID Primary Number	36
TABLE 3-5: Secondary Number Event Codes - 3+1, 4+1 Express and 4+1 Standard	37
TABLE 3-6: Secondary Number Event Codes - 4+2 Standard and 4+2 Express	38
TABLE 3-7: Ademco Contact ID Secondary Number	39
CHAPTER 4: Operating Instructions	40
4.1: Normal Mode.....	40
4.1.1: Keypad Functions.....	40
4.1.2: Displays.....	41
FIGURE 4-1: UDACT-F Phone Connectors and LEDs	42
4.1.3: Normal Mode Operation	42
4.1.4: Key Report Descriptions	44
4.2: Type Mode.....	44
4.2.1: Disabling of Zones or Points	45
4.2.2: Zone or Point Supervisory.....	45
4.3: Troubleshoot Mode.....	46
FIGURE 4-2: Handset/Speaker Connection	46
4.4: Lamp Test Mode.....	46
Appendix A: Reporting Formats	47
TABLE A-1: Data Reporting Structure	47
TABLE A-2: Letter Code Definitions for Table A-1	48
TABLE A-3: Ademco Contact ID Reporting Structure	49
TABLE A-4: Addressable Module Reporting Structure	50
TABLE A-5: Zone Reporting Structure	50
Appendix B: Compatible Receivers	51
TABLE B-1: Compatible UL Listed Receivers	51
Appendix C: Programming Reference Sheets	52
Appendix D: Point Assignments - MS-9200	56
Appendix E: Code Wheel Matching Point Assignments - MS-9200	57
Appendix F: Point Assignments - MS-9600	58
F.1: Type Mode Programming	58
F.1.1: For Zone Identification:	58
F.1.2: For Point Identification:	58
F.2: Event Code/Report Transmission	58
F.2.1: For Zone Reporting:	58
F.2.2: For Point Reporting:	58
F.3: Point Assignments	59
Appendix G: Zone Assignments	64

CHAPTER 1 *Product Description*

The Universal Digital Alarm Communicator/Transmitter (UDACT-F) may be used with the Fire•Lite MS-9200, MS-9600 and Sensiscan 2000 FACP's (Fire Alarm Control Panels). The UDACT-F transmits system status to UL listed Central Station Receivers via the public switched telephone network. The UDACT-F is compact in size and may be mounted inside the host FACP or may mount externally in a separate enclosure. EIA-485 annunciator communications bus and 24 volt (nominal) connections are required. The UDACT-F is capable of reporting 198 points or 56 zones when used with the MS-9200, 636 points or 99 zones when used with the MS-9600 and 56 zones when used with the Sensiscan 2000.

1.1 Product Features

- Dual telephone lines
- Dual telephone line voltage detect
- UL recognized "Dialer Runaway" prevention
- Compact in size: 6.75" (17.145 cm) x 4.25" (10.795 cm)
- Built-in programmer
- Built-in four character red 7-segment LED display
- Manual test report function
- Manual master transmission clear function
- Mounts either inside control panel or in separate ABS-8RF or UBS-1F enclosure
- Communicates vital system status including:
 - ✓ Independent zone/point alarm
 - ✓ Independent zone/point trouble
 - ✓ Independent zone/point supervisory
 - ✓ AC (mains) power loss - programmable
 - ✓ Low battery and earth fault
 - ✓ System off-normal
 - ✓ 12 or 24 hour test signal
 - ✓ Abnormal test signal per new UL requirements
 - ✓ Annunciation of UDACT-F troubles, including loss of phone lines, communication failure with either Central Station and total communication failure
- Troubleshoot Mode converts keypad to DTMF touchpad
- Individual LEDs for:
 - ✓ Power
 - ✓ EIA-485 loss
 - ✓ Manual Test
 - ✓ Kissoff
 - ✓ Comm Fail
 - ✓ Primary Line Seize
 - ✓ Secondary Line Seize
- Open collector relay driver for Total Communication Failure or UDACT-F trouble
- Real Time Clock
- Extensive transient protection
- Simple EIA-485 interface to host panel

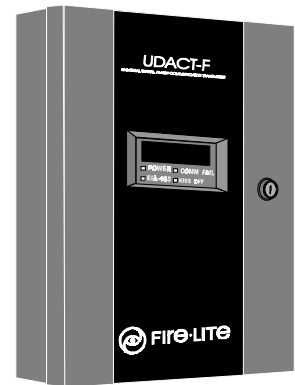

UBS-1F

FIGURE 1-1: UDACT-F Assembly

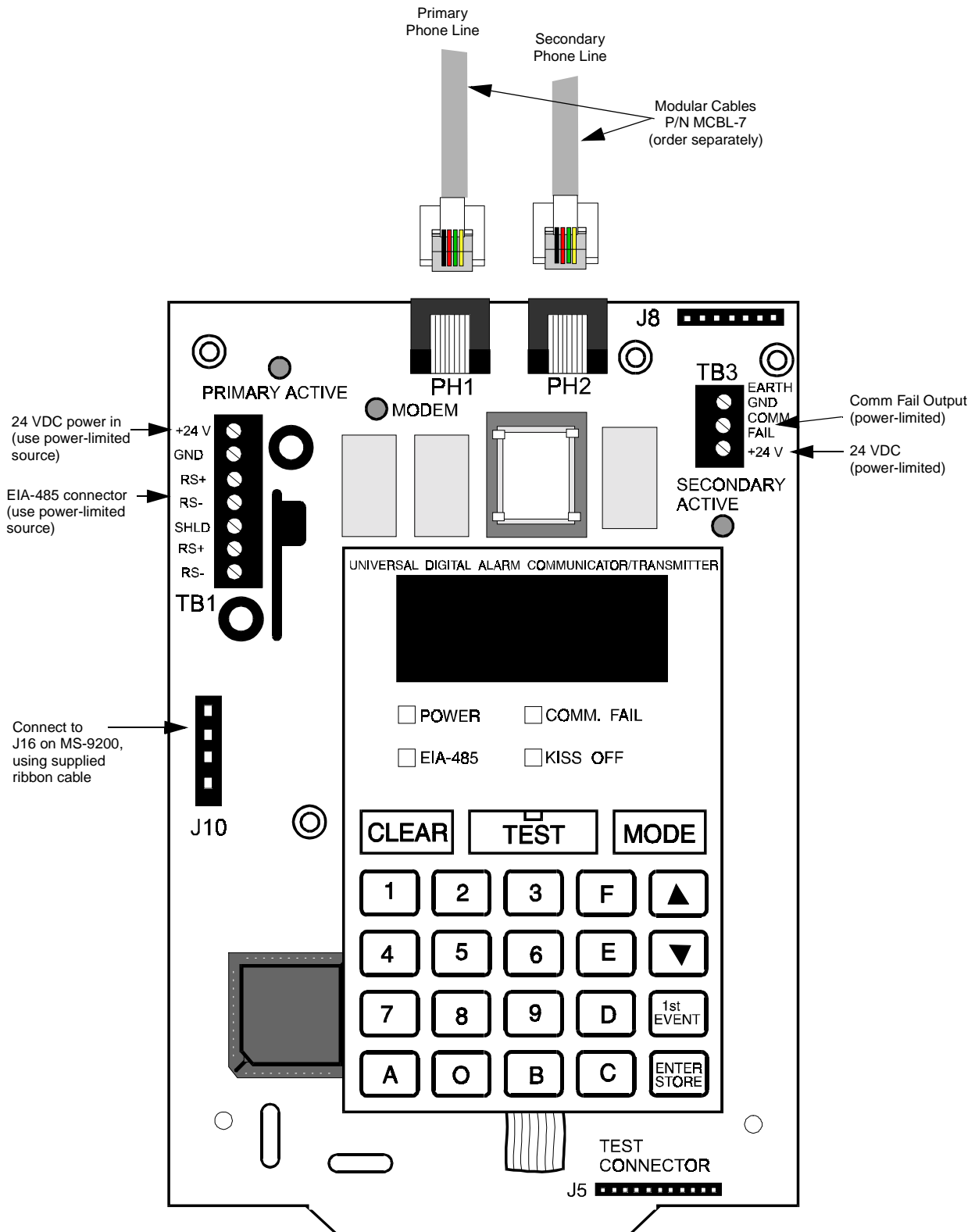

1.2 Controls and Indicators

Front Panel Switches

CLEAR	Digits 0 - 9
TEST	A
MODE	B
Up Arrow	C
Down Arrow	D
1st EVENT	E
ENTER/STORE	F

Displays

- EIA-485 - yellow LED
- COMM. FAIL - yellow LED
- KISS OFF - green LED
- POWER - green LED
- Four 7-Segment Displays - red
- Primary Phone Line Active - red LED
- Secondary Phone Line Active - red LED
- TEST - green LED

FIGURE 1-2: Controls and Indicators

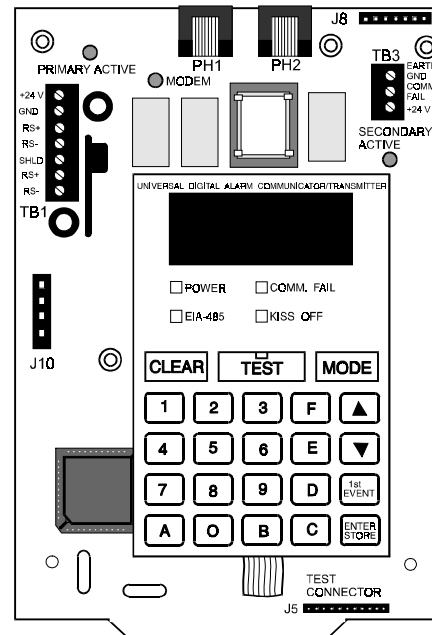

1.3 Compatible Panels

The UDACT-F has been designed to be compatible with the following Fire•Lite control panels:

- Sensiscan 2000
- MS-9200
- MS-9600

1.4 Digital Communicator

Two modular phone jacks allow easy connection to telephone lines. Modular jacks are labeled PH1 and PH2 for the Primary and Secondary phone lines. Telephone line 'Primary and Secondary Active' red LEDs are provided as well as a green 'Kissoff' LED. The integral digital communicator provides the following functions:

- Line Seizure - takes control of the phone lines disconnecting any premises phones
- Off/On Hook - perform on and off-hook status to the phone lines
- Listen for dial tone - 440 hertz tone typical in most networks
- Dialing the Central Station(s) number - default is Touch-Tone®, programmable to rotary
- For tone burst or touchtone type formats: Discern proper 'Ack' and 'Kissoff' tone(s) - the frequency and time duration of the tone(s) varies with the transmission format. The UDACT-F will adjust accordingly.
- Communicate in the following formats (refer to "Compatible Receivers" on page 51, for a list of compatible receivers):
 - ✓ 6 Tone Burst Types: 20 pps (3+1 Standard & Express, 4+1 Standard & Express, 4+2 Standard & Express)
 - ✓ 3 Touchtone Types: (4+1 Ademco Express, 4+2 Ademco Express, Ademco Contact ID)

1.5 Circuits

The UDACT-F circuit board contains a CPU, other primary components and wiring interface connectors

1.5.1 Power Requirements

Operating voltage for the UDACT-F must be power-limited, filtered, nonresettable 21.2 to 28.2 volts. The 24 VDC nominal operating power must be supplied by the control panel and is connected to TB1 of the UDACT-F.

Note: If the UDACT-F is installed in an MS-9200 FACP, power is provided directly through UDACT-F connector J10 which connects via supplied ribbon cable to the MS-9200 main circuit board connector J16.

1.5.2 Communications

Communications between the UDACT-F and the host FACP is accomplished over a two-wire EIA-485 serial interface which is power-limited and supervised by the control panel and the UDACT-F. The wiring connections are made to the RS+, RS- and Shield terminals of TB1 on the UDACT-F.

The EIA-485 circuit cannot be T-tapped and must be wired in a continuous fashion from the control panel to the UDACT-F and, if installed, an annunciator. The wire must be 12 AWG to 18 AWG (0.75 to 3.25 mm²) twisted, shielded pair cable with a characteristic impedance of 120 ohms (+/- 20%). Limit the total wire resistance to 100 ohms on the EIA-485 circuit. Do not run cable adjacent to, or in the same conduit as, 120 VAC service, noisy electrical circuits that are powering mechanical bells or horns, audio circuits above 25 volts_{RMS}, motor control circuits or SCR power circuits.

Note: If the UDACT-F is installed in an MS-9200 FACP, the EIA-485 data line is supplied directly through UDACT-F connector J10 which connects via supplied ribbon cable to the MS-9200 main circuit board connector J16.

1.5.3 Primary and Secondary Phone Lines

Modular jacks are used to interface the primary and secondary phone lines to the public telephone network.

1.5.4 Communicator Fail Relay Driver

Relay driver output for Central Station communication failure is provided.

1.5.5 Earth Ground

Connect a separate earth ground wire to TB3 terminal 1 for transient protection. When mounted in the MS-9200 or MS-9600, the UDACT-F receives an earth ground connection via the upper right corner mounting position.

1.6 Specifications

DC Power - TB1, Terminals 1 & 2

24 VDC (nominal) filtered, nonresettable and power-limited. Voltage range is 21.2 to 28.2 volts. DC power TB1 Terminals 1(+), 2(-) 40 mA in standby, 75 mA maximum while communicating (for MS-9200 installation, use connector J10) and 100 mA with the open collector output engaged and communicating.

Data Communications - TB1, Terminals 3 - 7

EIA-485 serial interface, TB1 Terminal 3 = RS+, 4 = RS-, 5 = Shield, 6 = future use, 7 = future use. Power-limited source must be used. (For MS-9200 installation, use connector J10).

Auxiliary Output - TB3, Terminals 2 & 3

TB3 Terminal 2 = Communicator Failure. Power-limited circuit. An open collector type output, normally high, active low which sinks up to 40 mA. TB3 Terminal 3 = 21.2 to 28.2 volts, power-limited. Use UL listed relay P/N MR-101/C or MR-201/C with this output.

Earth Ground - TB3, Terminal 1

TB3 Terminal 1 = Earth Ground connection. Connect this terminal to building earth ground using solid minimum 12 AWG (3.25 mm²) wire to provide lightning protection. This connection is not required when the UDACT-F is mounted in an MS-9200 or MS-9600 since the upper right mounting hole provides an earth ground connection.

1.7 Telephone Requirements and Warnings**1.7.1 Telephone Circuitry - PH1 & PH2**

Ringer Equivalence Number (REN) = 0.6B
 AC Impedance 10.0 Mega Ohm
 Complies with FCC Part 68
 Mates with RJ31X Male Connector
 Supervision Threshold: less than 4.0 volts for 2 minutes

The REN is used to determine the quantity of devices which may be connected to the telephone line. Excessive RENs on the telephone line may result in the devices not ringing in response to an incoming call. In most, but not all areas, the sum of the RENs should not exceed five (5.0). To be certain of the number of devices that may be connected to the line, as determined by the total RENs, contact the telephone company to determine the maximum REN for the calling area.

1.7.2 Digital Communicator

Before connecting the UDACT-F to the public switched telephone network, the installation of two RJ31X jacks is necessary. The following information is provided if required by the local telephone company:

Manufacturer: Fire•Lite Alarms, Inc.
 One Firelite Place
 Northford, CT 06472

Product Model Number: UDACT-F
 FCC Registration Number: 1W6USA-20723-AL-E
 Ringer Equivalence Number: 0.6B

1.7.3 Telephone Company Rights and Warnings:

The telephone company, under certain circumstances, may temporarily discontinue services and/or make changes in its facilities, services, equipment or procedures which may affect the operation of this digital communicator. However, the telephone company is required to give advance notice of such changes or interruptions.

If the digital communicator causes harm to the telephone network, the telephone company reserves the right to temporarily discontinue service. Advance notification will be provided except in cases when advance notice is not practical. In such cases, notification will be provided as soon as possible. The opportunity will be given to correct any problems and to file a complaint.

DO NOT CONNECT THIS PRODUCT TO COIN TELEPHONE, GROUND START OR PARTY LINE SERVICES.

When the digital communicator activates, premise phones will be disconnected.

Two separate phone lines are required. Do not connect both telephone interfaces to the same telephone line.

The digital communicator must be connected to the public switched telephone network upstream of any private telephone system at the protected premises.

An FCC compliant telephone cord must be used with this equipment. This equipment is designed to be connected to the telephone network or premises wiring using a compatible RJ31X male modular plug which is Part 68 compliant.

1.7.4 For Canadian Applications

The following is excerpted from CP-01 Issue 5:

“NOTICE: The Industry Canada (IC) label identifies certified equipment. This certification means that the equipment meets certain telecommunications network protective, operational and safety requirements as prescribed in the appropriate Terminal Equipment Technical Requirements document(s). The Department does not guarantee the equipment will operate to the user’s satisfaction.”

Before installing this equipment, users should ensure that it is permissible to be connected to the facilities of the local telecommunications company. The equipment must also be installed using an acceptable method of connection. The customer should be aware that compliance with the above conditions may not prevent degradation of service in some situations.

Repairs to certified equipment should be made by an authorized Canadian maintenance facility designated by the supplier. Any repairs or alterations made by the user to this equipment, or equipment malfunctions, may give the telecommunications company cause to request the user to disconnect the equipment.

Users should ensure for their own protection that the electrical ground connections of the power utility, telephone lines and internal metallic water pipe system, if present, are connected together. This precaution may be particularly important in rural areas.

CAUTION

Users should not attempt to make such connections themselves, but should contact the appropriate electric inspection authority or electrician.

“The Ringer Equivalence Number (REN) assigned to each terminal device provides an indication of the maximum number of terminals allowed to be connected to a telephone interface. The termination of an interface may consist of any combination of devices subject only to the requirement that the sum of the REN of all devices does not exceed 5.”

Representative: NOTIFIER/FIRE-LITE, CANADA
 24 Viceroy Road
 Concord, Ontario L4K2L9

IC Certificate Number: 2132 6030 A
Ringer Equivalence Number (REN): 0.6B
Load Number: 3

1.8 Modes and Special Functions

1.8.1 Normal Mode

Normal Mode is the standard mode of operation. In this mode, the UDACT-F monitors host FACP status as well as monitoring telephone line voltage. The UDACT-F reports system status information to UL listed Central Stations. Information transmitted includes general alarm, trouble and supervisory. It also transmits either the number of zones or points activated or the specific point(s) activated. Specific system trouble conditions and specific UDACT-F troubles are also transmitted.

1.8.2 Program Mode

Program Mode is used to program the UDACT-F. While the UDACT-F is in the program mode, it cannot receive host FACP status information. Refer to “Programming Instructions” on page 27, for complete programming instructions.

1.8.3 Lamp Test Mode

This mode turns on all segments of the four character display plus all LEDs on the UDACT-F.

1.8.4 Troubleshoot Mode

Troubleshoot Mode may be used for testing the telephone line wiring. Connection from the UDACT-F's modular jacks, through RJ31X jacks and into the telephone network may be easily checked. In this mode, the keypad acts similar to a telephone touchpad.

1.8.5 Type Mode

Type Mode is used to define the specific type of device (point) used or function of a zone. This mode is also used to disable the alarm report for any zone/point in the system. The feature which disables the zone/point alarm report must be used for zones/points programmed into the host FACP as remote silence, reset, drill or acknowledge switches.

1.8.6 Clear Function

When the clear function is activated, it causes the UDACT-F to immediately stop transmissions, hang-up from the telephone network, clear out any messages that were waiting for transmission and reset.

1.8.7 Manual Test Function

The manual test function allows for a test report message to be sent to both Central Stations upon activation.

CHAPTER 2 *Installation*

2.1 Mounting Options

The UDACT-F may be mounted in the control panel or mounted remotely in an ABS-8RF or UBS-1F enclosure up to 6,000 feet (1,800 m) away from the control panel. All power must be removed from the FACP before making any connections to prevent circuit damage. The EIA-485 serial interface is connected between the control panel and UDACT-F using twisted, shielded pair wire. Power should be wired from the control panel's 24 VDC (nominal) filtered, nonresettable output to TB1 on the UDACT-F (except when mounted in the MS-9200).

FIGURE 2-1: ABS-8RF

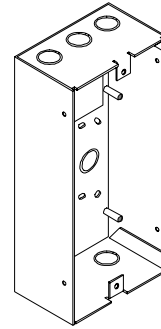

2.2 Panel Mounting

2.2.1 MS-9200

The MS-9200 must have firmware with a Part Number of 73580 or higher installed to allow use of the UDACT-F. Remove all power from the MS-9200 by disconnecting AC and batteries. Install the supplied standoffs (three nylon and one aluminum standoff) in the appropriate holes located on the right side of the MS-9200 main circuit board as illustrated in Figure 2-2. Using the ribbon cable supplied with the UDACT-F, connect J10 on the UDACT-F to J16 on the MS-9200. Note that the colored edge of the ribbon cable must be oriented toward the top edge of the UDACT-F as illustrated in Figure 2-2. Carefully seat the UDACT-F on the nylon standoffs and secure to the aluminum standoff with the supplied screw.

The EIA-485 circuit and 24 VDC power are provided directly from connector J16 of the MS-9200. Note that a 120 ohm EOL resistor is not required on the UDACT-F EIA-485 terminals when it is installed inside the MS-9200 cabinet. The EOL resistor is required at the last device on the EIA-485 line, external to the MS-9200.

FIGURE 2-2: UDACT-F Mounting to MS-9200

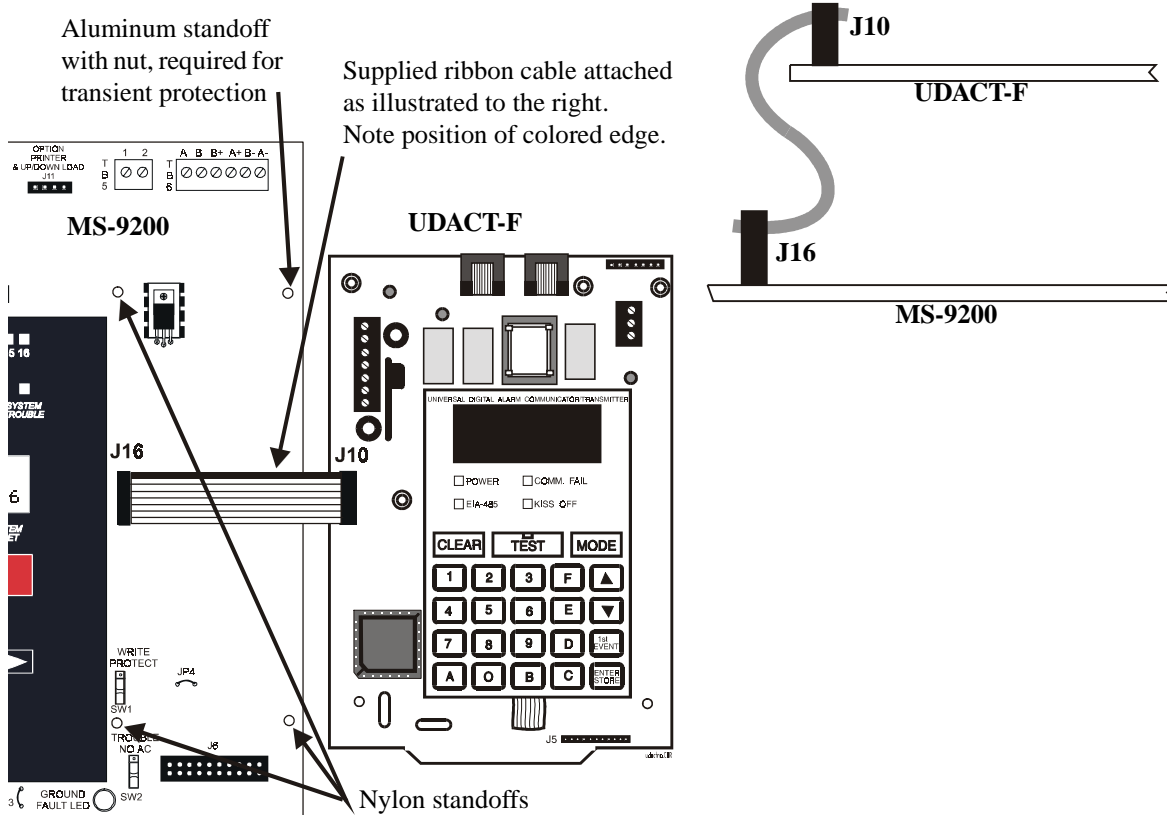
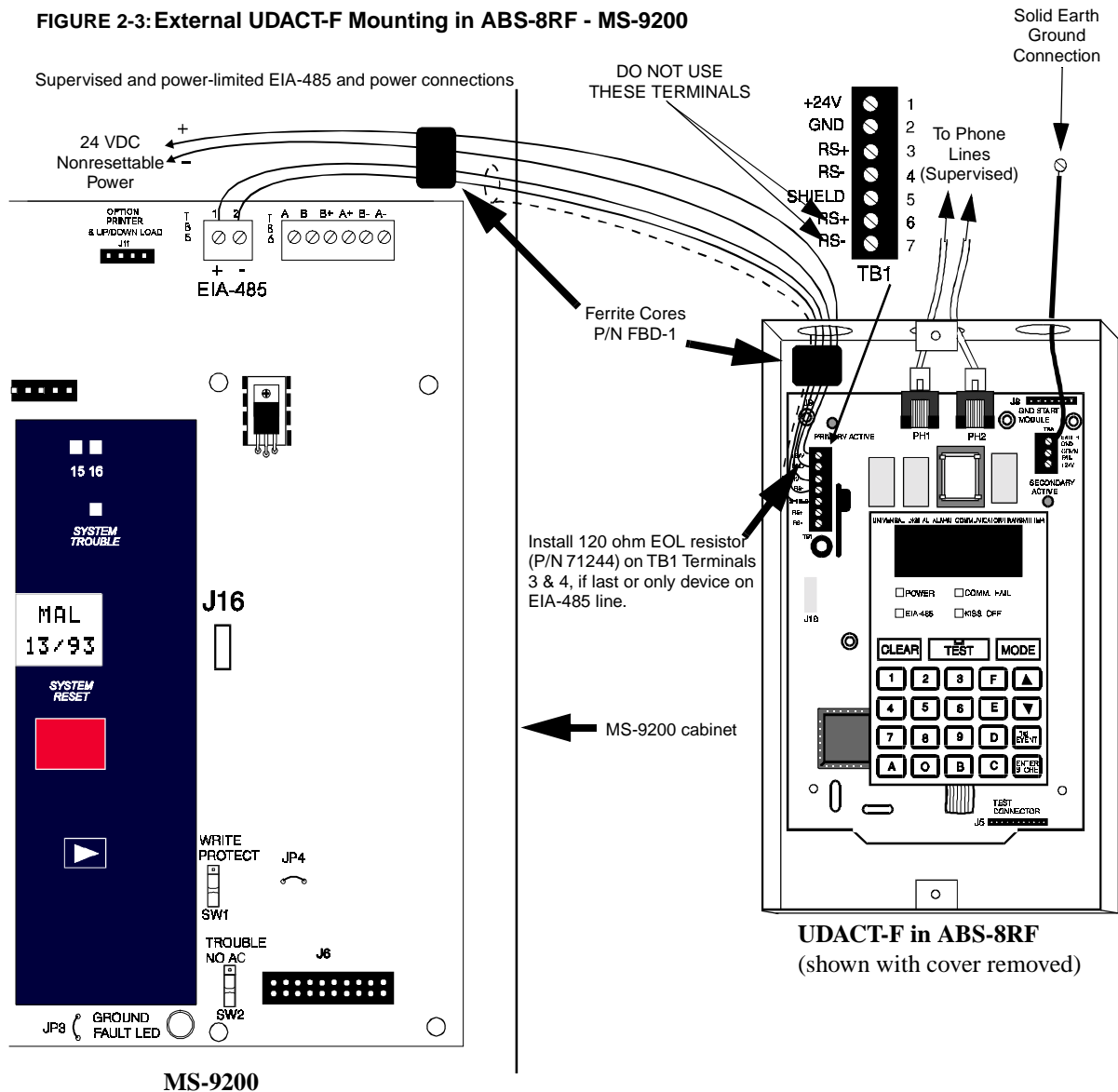

FIGURE 2-3: External UDACT-F Mounting in ABS-8RF - MS-9200



Notes:

1. This arrangement allows use of the UDACT-F simultaneously with the RTM-8F module
2. Ferrite cores are recommended for all applications
3. Recommended wire is 12 AWG to 18 AWG (0.75 to 3.25 mm²) twisted wire
4. Shielded wire is not required (unless mandated by local AHJ)
If shield wire is used, connect only one end of the shield:
 - ✓ shield may be connected to cabinet (earth ground) at fire alarm panel, or
 - ✓ shield may be connected to TB1 Terminal 5 (shield) at UDACT-F as shown in Figure 2-3. *Note that the shield end that is not connected should be insulated to prevent accidental grounding. Do not connect both ends of the shield under any circumstance, since a ground fault may result.*
5. Conduit is recommended for external wire runs. Consult local building codes
6. Connect Ground Strap (supplied with ABS-8RF enclosure) from Earth Ground terminal on the UDACT-F to a solid building earth ground. Conduit alone will not provide a reliable earth ground.
7. UDACT-F may be located up to 6,000 feet (1,800 m) away from the host control panel
8. Refer to "Specifications" on page 10, for power requirements

CAUTION: Connecting a UDACT-F to an MS-9200 which also has an ACM, AFM or LDM Series annunciator connected, will alter the assignments of the first eight yellow LEDs on the annunciator as follows:

TABLE 2-1: Annunciator LED Assignments (MS-9200)

Yellow Annunciator LED	Assignment Without UDACT-F	Assignment With UDACT-F
1	System Trouble (less AC loss)	System Trouble (less AC loss)
2	Signals Silenced	Signals Silenced
3	Not Used	Program Mode (panel off-normal)
4	Not Used	Supervisory
5	Supervisory	Bell Trouble
6	Prealarm	Prealarm/Maintenance Alert
7	AC Fail	Low Battery
8	Panel Trouble	AC Fail

2.2.2 MS-9600

The UDACT-F may be mounted to a BRKT-9600 bracket inside the FACP cabinet (see MS-9600 instruction manual) or mounted remotely in a UBS-1F or ABS-8RF enclosure (see Figure 2-3) and wired according to the diagram below.

FIGURE 2-4: UDACT-F Wiring to MS-9600

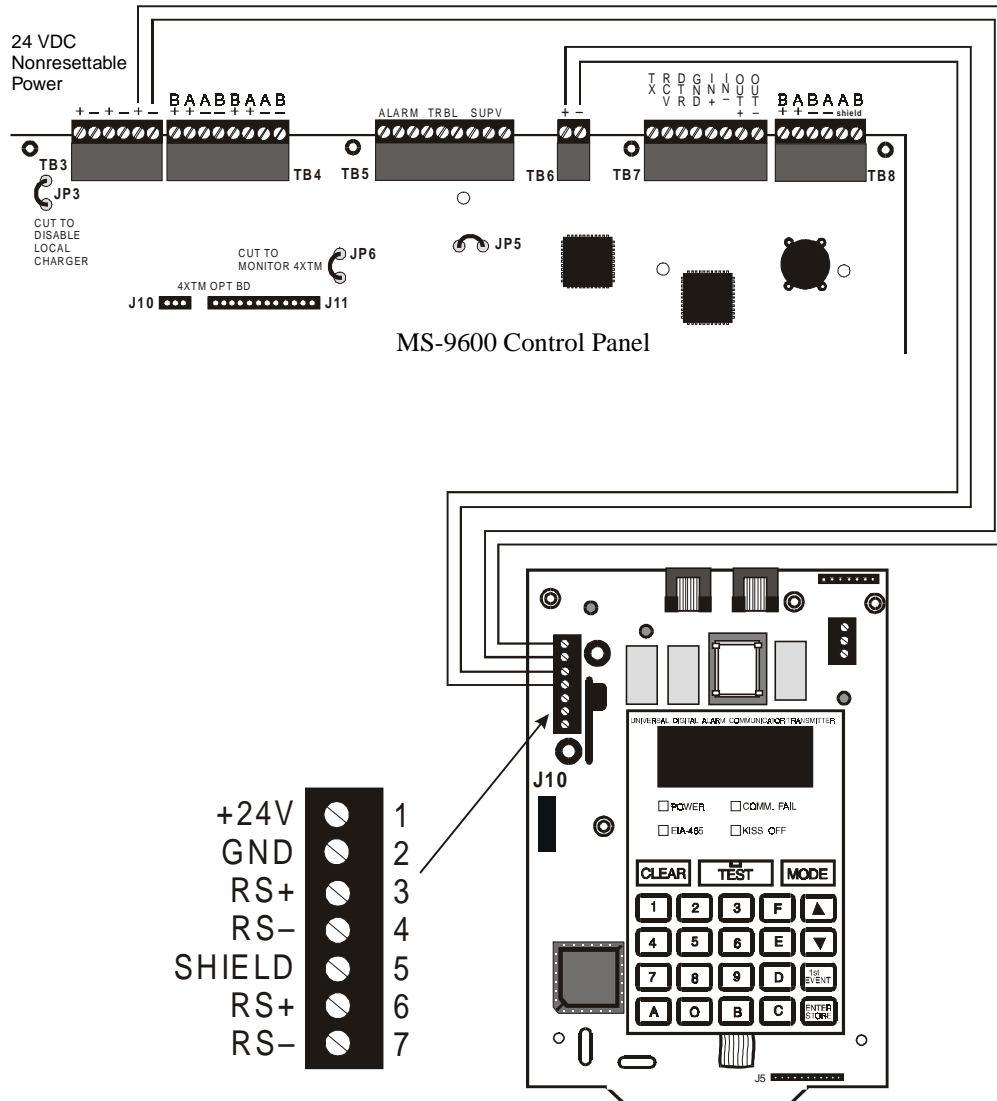

Notes for External Applications:

1. Ferrite cores are recommended for all applications
2. Recommended wire is 12 AWG to 18 AWG (0.75 to 3.25 mm²) twisted wire
3. Shielded wire is not required (unless mandated by local AHJ)
If shield wire is used, connect only one end of the shield:
 - ✓ shield may be connected to cabinet (earth ground) at fire alarm panel, or
 - ✓ shield may be connected to TB1 Terminal 5 (shield) at UDACT-F as shown in Figure 2-3. *Note that the shield end that is not connected should be insulated to prevent accidental grounding. Do not connect both ends of the shield under any circumstance, since a ground fault may result.*
4. Conduit is recommended for external wire runs. Consult local building codes
5. Connect Ground Strap (supplied with ABS-8RF enclosure) from Earth Ground terminal on the UDACT-F to a solid building earth ground. Conduit alone will not provide a reliable earth ground.
6. UDACT-F may be located up to 6,000 feet (1,800 m) away from the host control panel
7. Refer to “Specifications” on page 10, for power requirements

Connecting a UDACT-F to an MS-9600 which also has an ACM, AFM or LDM Series annunciator connected, will not alter the assignments of the first eight yellow LEDs on the annunciator.

TABLE 2-2: Annunciator LED Assignments (MS-9600)

Yellow Annunciator LED	Assignment With or Without UDACT-F
1	System Trouble (less AC loss)
2	Signals Silenced
3	Program Mode (panel off-normal)
4	Supervisory
5	Bell Trouble
6	Prealarm/Maintenance Alert
7	Low Battery
8	AC Fail

2.2.3 Sensiscan 2000

Remove all power from the control panel by disconnecting AC and batteries. Install the three supplied nylon support posts for the top and bottom left of the UDACT-F, one aluminum/nylon and one aluminum standoff in the CHS-4 chassis slot in which the UDACT-F is to be installed (refer to Figure 2-5). Position the UDACT-F on the standoffs and secure on the aluminum standoff with a #6-32 screw. Alternatively, the UDACT-F may be mounted remotely using an ABS-8RF or UBS-1F enclosure. Ferrite cores are recommended for this application. Refer to Figure 2-3, "External UDACT-F Mounting in ABS-8RF - MS-9200," on page 15, and the accompanying notes for wiring alternatives.

Connect the communication line between the EIA-485 terminal block on the CPU-2000 and TB1 Terminals 3 & 4 on the UDACT-F, making certain to observe polarity. Refer to Figure 2-6, "EIA-485 Connection Sensiscan 2000," on page 20. Recommended wire is 12 AWG to 18 AWG (0.75 to 3.25 mm²) twisted pair. If no other devices are connected to the EIA-485 line, install a 120 ohm EOL resistor across the UDACT-F TB1 Terminals 3 & 4.

Connect the supplied Ground Strap from the UDACT-F Earth Ground terminal on TB3 to the CHS-4 chassis. Connect 24 VDC filtered, nonresettable power to TB1 Terminals 1 & 2 on the UDACT-F. Refer to Figure 2-7, "24 VDC Power Connection to UDACT-F," on page 21.

FIGURE 2-5: UDACT-F Mounting in CHS-4

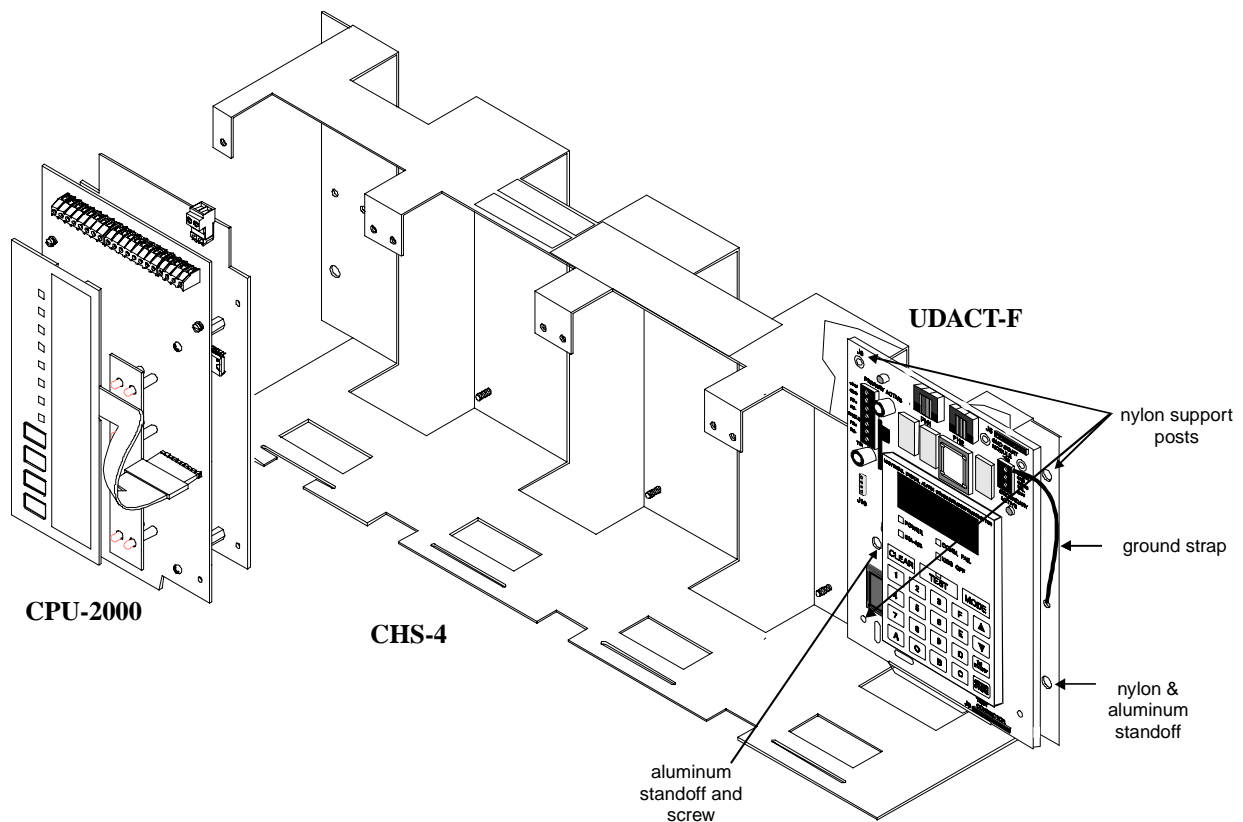

FIGURE 2-6: EIA-485 Connection Sensiscan 2000

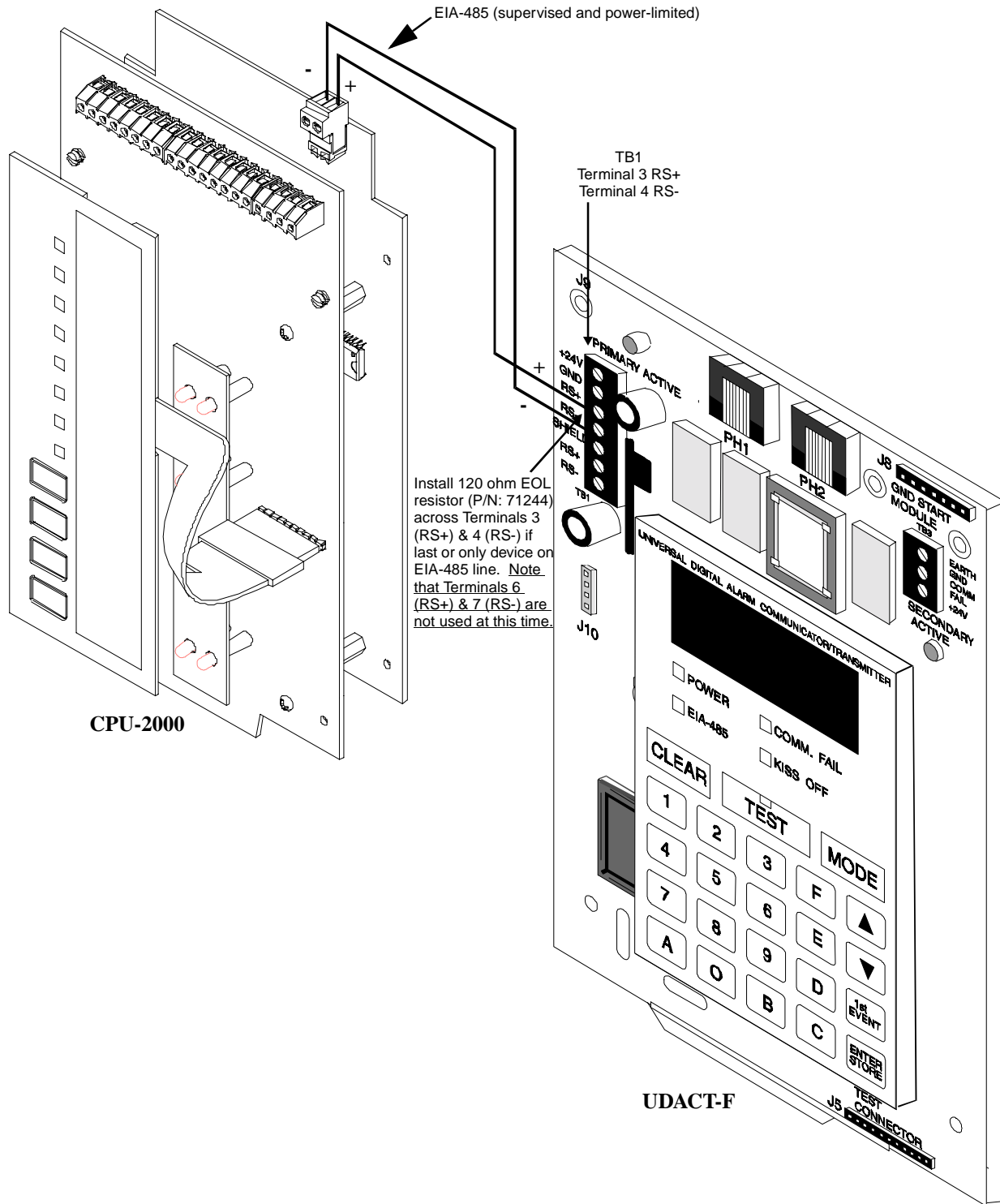
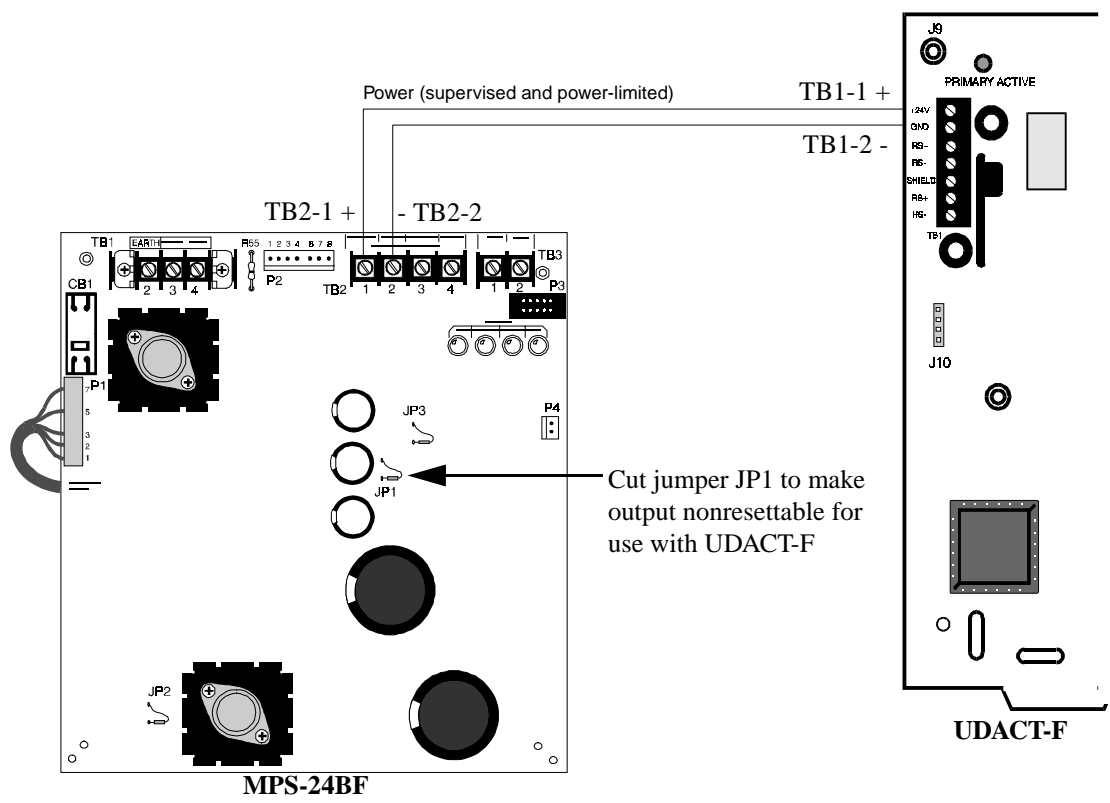
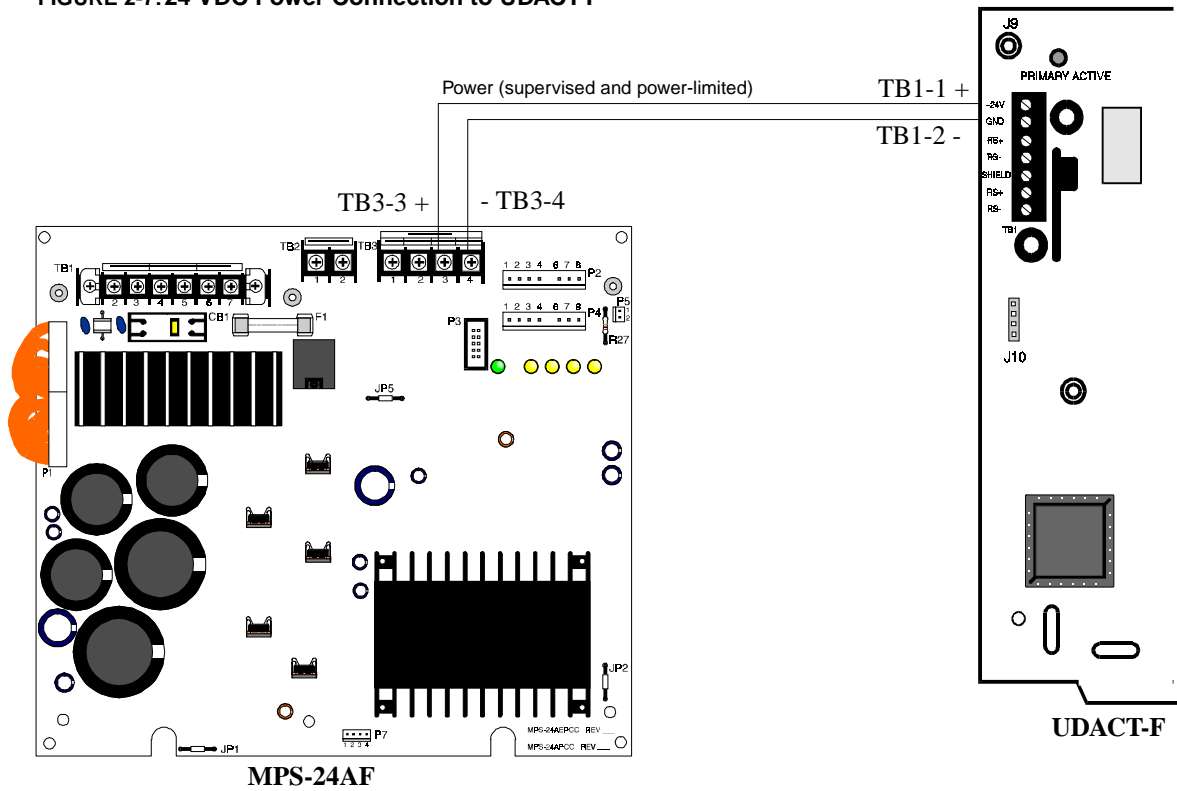

FIGURE 2-7: 24 VDC Power Connection to UDACT-F



Note: Power for the UDACT-F must be 24 VDC filtered, nonresettable

CAUTION: Connecting a UDACT-F to a Sensiscan 2000, which also has an AFM or LDM series annunciator connected, will alter the assignments of the first eight yellow LEDs on the annunciator as follows:

TABLE 2-3: Sensiscan 2000 Annunciator LED Assignments

Yellow Annunciator LED	LED Assignment Without UDACT-F	LED Assignment With UDACT-F
1	System Trouble (less AC loss)	System Trouble (less AC loss)
2	Signals Silenced	Signals Silenced
3	Not Used	Not Used
4	Supervisory	Supervisory
5	Indicating Circuit #1 Trouble	Indicating Circuit #1 Trouble
6	Indicating Circuit #2 Trouble	Indicating Circuit #2 Trouble
7	Municipal Tie Trouble	Low Battery/Ground Fault
8	AC Fail	AC Fail

2.3 UL Power-limited Wiring Requirements

Power-limited and nonpower-limited circuit wiring must remain separated in the cabinet. All power-limited circuit wiring must remain at least 0.25" away from any nonpower-limited circuit wiring. Furthermore, all power-limited circuit wiring and nonpower-limited circuit wiring must enter and exit the cabinet through different knockouts and/or conduits. A typical wiring diagram for the UDACT-F is shown below.

FIGURE 2-8: Typical Wiring Diagram for UL Power-limited Requirements

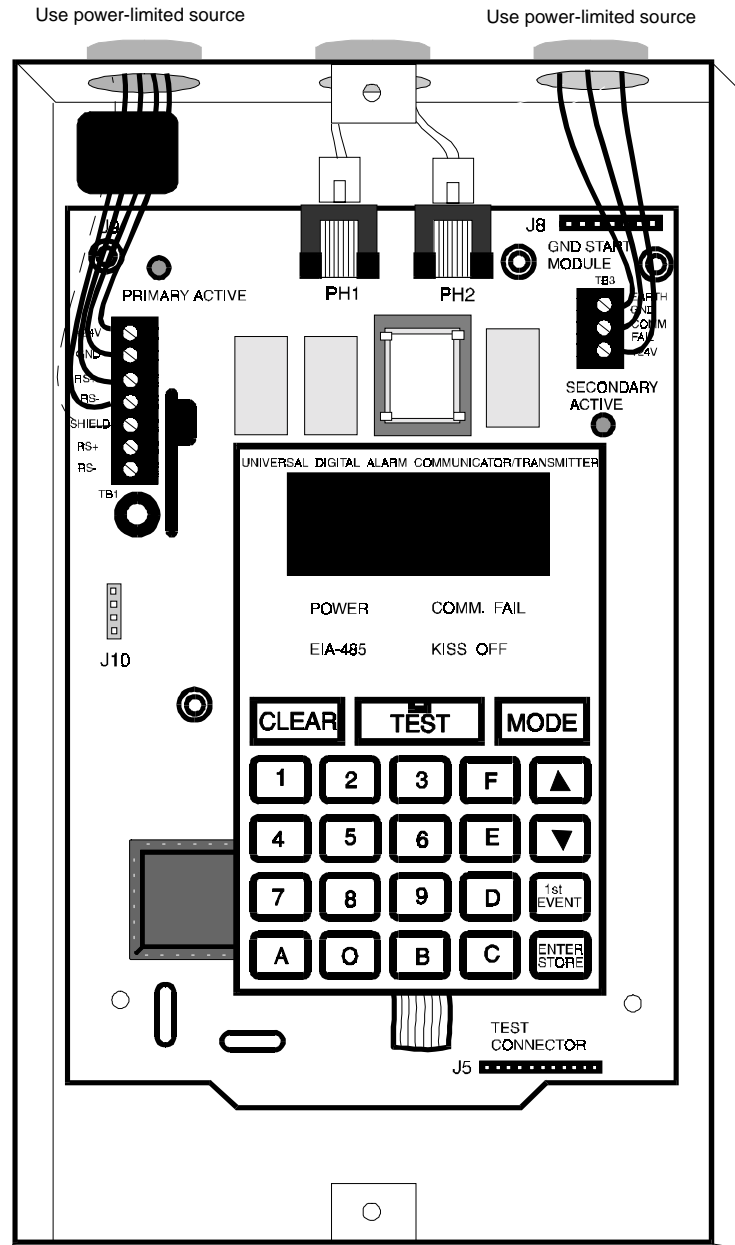

2.4 Output Circuits

2.4.1 Telephone Circuits

Provision to connect to two independent telephone lines is available via two telephone jacks labeled PH1 (Primary) and PH2 (Secondary). Telephone line control/command is possible via double line seizure as well as usage of an RJ31X style interconnection. The RJ31X jacks must be ordered separately.

Note that it is critical that the UDACT-F be located as the first device on the incoming telephone circuit to properly function.

FIGURE 2-9: Wiring Phone Jacks

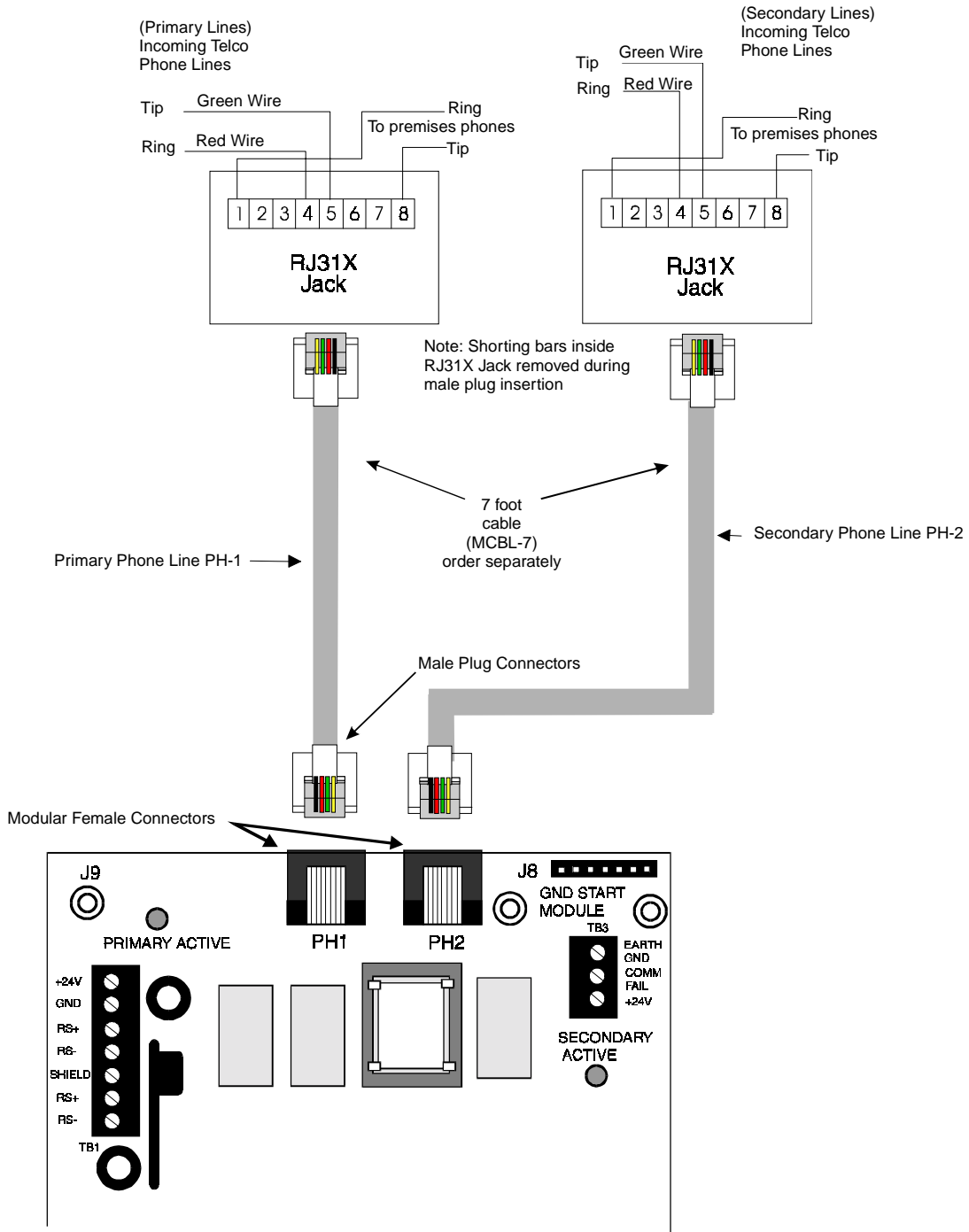

2.4.2 Relay Driver

The UDACT-F's open collector output on TB3, Terminal 2, is provided for Communicator Failure and UDACT-F trouble. It can be used to drive UL listed relay MR-101/C or MR-201/C. The output is rated for 40 mA. The normal condition for the output is Off (deenergized).

Communicator Failure occurs when the maximum number of attempts to reach both Central Stations has taken place or when both phone lines are disconnected. UDACT-F trouble conditions include loss of telephone line voltage to the primary and/or secondary phone lines, communication failure to the primary or secondary Central Stations or total communication failure.

Wiring from the UDACT-F terminal block TB3 to the relay must be in the same room no more than 20 feet (6 m) in length and enclosed in conduit. Wiring from the relay output contacts must also remain in the same room as the UDACT-F.

When the UDACT-F is programmed as 'Receive Only' (typically when annunciators are also used and are set for 'Receive/Transmit'), the relay output is used to provide a UDACT-F trouble input to the host control panel. For MS-9200 and MS-9600 applications, use a monitor module to supervise the relay closure (refer to Figure 2-11). Program the adjective and noun fields for 'UDACT-F Trouble'. For Sensiscan 2000 applications, wire the relay output to the annunciator trouble input circuit or use the relay to trigger zone trouble.

When the UDACT-F is programmed as 'Receive/Transmit', EIA-485 supervision and UDACT-F trouble status are automatically handled by the host control panel.

FIGURE 2-10:Relay Driver Connections

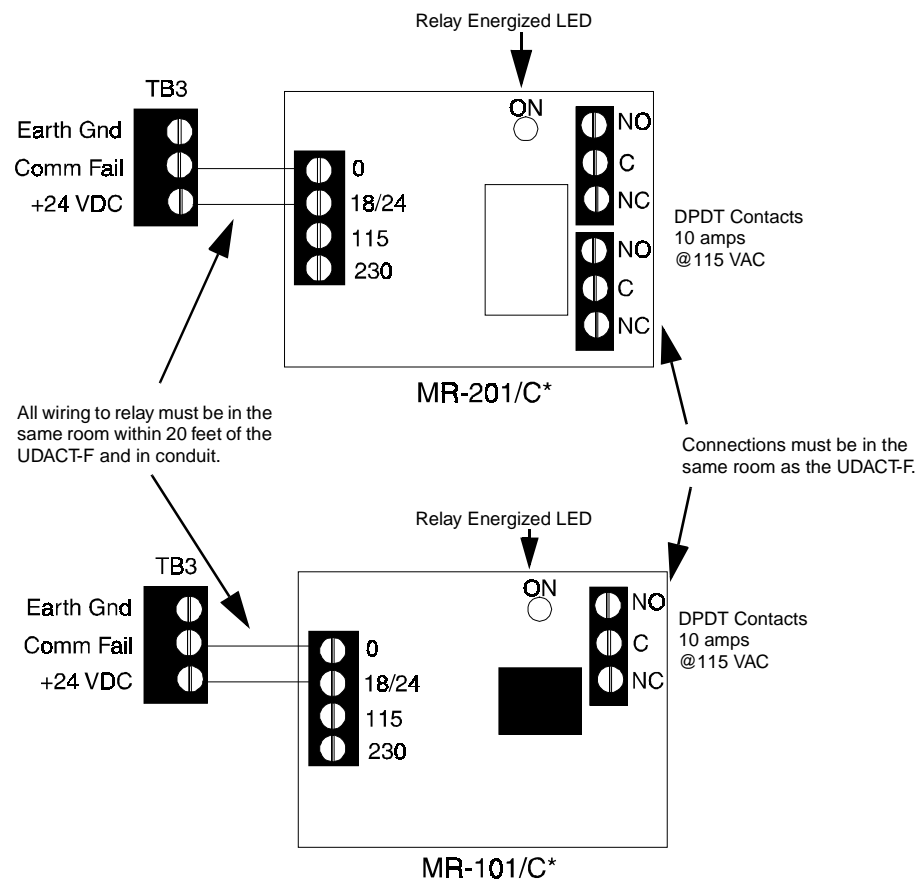

Note: The MR-101/C and MR-201/C include an enclosure.

FIGURE 2-11: Monitoring for UDACT-F Trouble

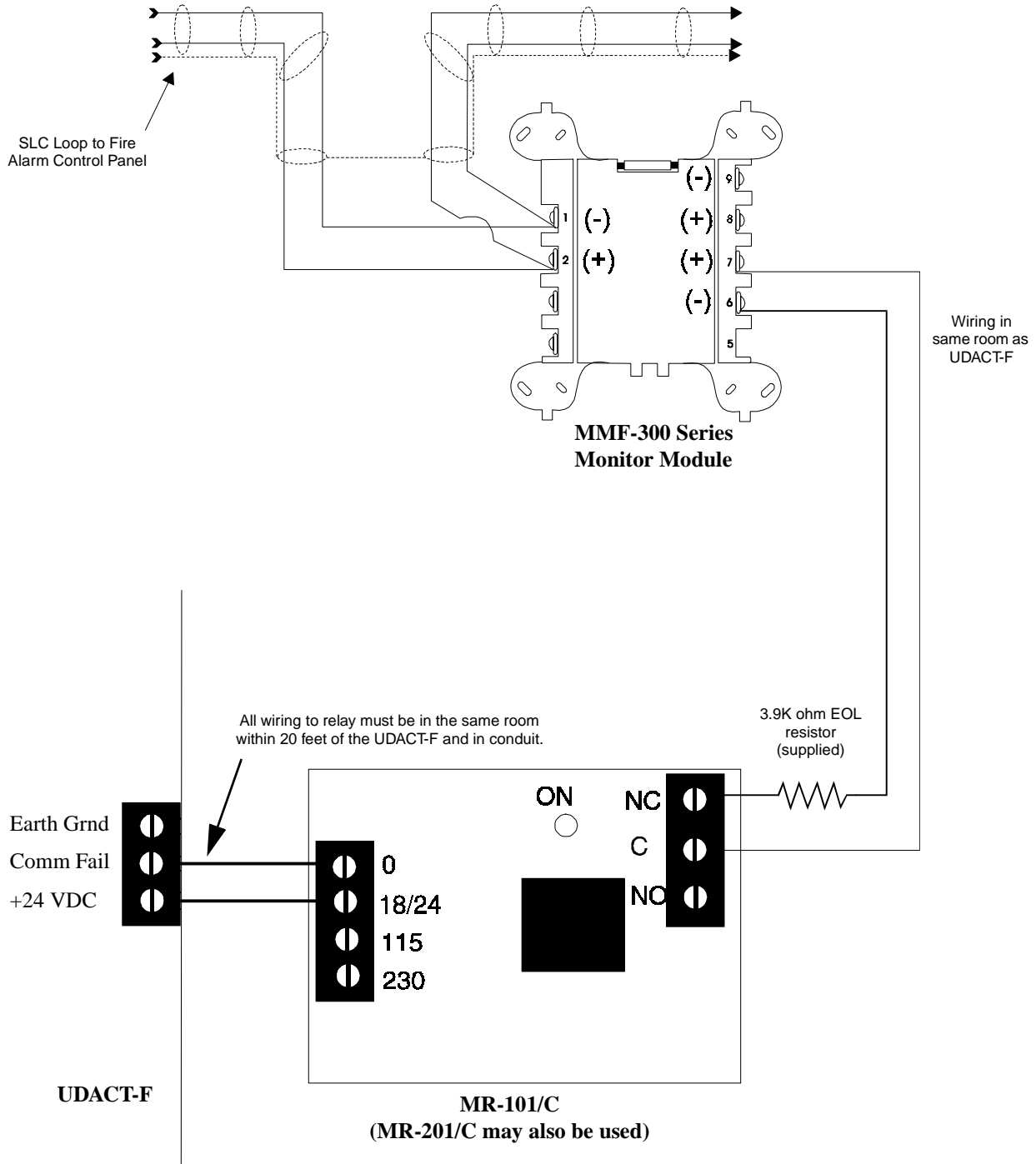

Note: MMF-300 Series Monitor Module is used to supervise Normally Closed output of MR-101/C. On UDACT-F trouble and Comm. Fail, MR-101/C relay contact will open, causing M300 to transmit trouble condition to the FACP.

CHAPTER 3 *Programming Instructions*

Programming of the UDACT-F is possible at any time including while the UDACT-F is communicating with a Central Station. The UDACT-F has been designed for many different types of applications. After examining your specific application, review the programming options and choose the entries best suited for your system.

The UDACT-F has a built-in programmer. All programming selections are stored in nonvolatile Electrically-Erasable Programmable Read-Only Memory (EEPROM). This ensures that the UDACT-F will retain all entries made in Programming Mode even if power is removed.

The user *must* program the primary and secondary phone numbers, account numbers and 24 hour test report times for each Central Station account and the current time. The UDACT-F comes with factory chosen options/features already programmed. Other options/features may be programmed if desired. If all factory default settings are acceptable, programming is complete.

3.1 Entering Program Mode

To enter the Program Mode, press the **MODE** key once (the display will go blank). The user then has ten seconds to start entering the code **7764**.

☛ **7764** spells PROG on a Touch-Tone® phone

If an incorrect key is entered, reenter the proper 4-digit code *before* pressing the **[ENTER/STORE]** key. Note that as the information is entered into the UDACT-F, the digits scroll across the display from right to left.

```

  ___7
  __77
  _776
  7764

```

The user is allowed a pause of up to 10 seconds in between each key stroke while entering the code. After pressing the **[ENTER/STORE]** key, the UDACT-F will be in Program Mode and display **00_F**. The user is allowed up to ten minutes of idle time at this point before starting the programming, otherwise, the UDACT-F will return to Normal Mode. The user also has a maximum of 10 minutes between any key stroke. All entries made prior to the 10 minute time-out are valid and stored.

Once in Programming Mode, the UDACT-F will:

- Ignore the Test and Clear keys
- Continue to communicate any events not previously acknowledge at the Central Station prior to entering Programming Mode

Location 56 is factory set to '0' for UDACT-F communications disabled. *This setting keeps the communicator off until location 56 is changed to 1, 2, 3, 4, 5 or 6. Refer to program selection for address 56 in this section. Once location 56 is changed from 0 to 1, 2, 3, 4, 5 or 6 and a valid phone number is entered, transmission of the 'UDACT-F Off Normal' report will occur.*

Throughout Programming Mode, the first three locations on the left of the display represent the memory address which can range from 00 to 208 (alpha characters are not used). The last location (farthest right) represents the contents of the memory address. The first address displayed is shown below:

```

  00_F
  (address)(data)

```

3.2 Switch (Key) Functions

The function of each switch (key) in Program Mode is illustrated in Figure 3-1.

FIGURE 3-1: UDACT-F Keypad

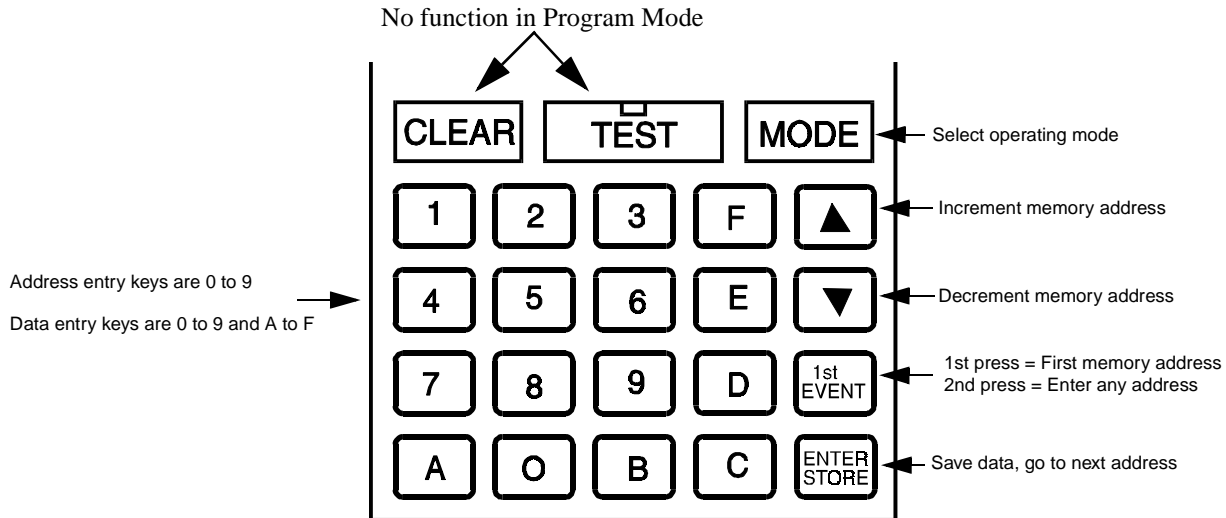

3.3 Programming Options

Primary Phone Number (00-15)

The first sixteen addresses are factory set to 'F' (from **00_F** to **15_F**). Programming is typically done as follows:

- ✓ If the phone number to be entered is 484-7161, press **4**
- ✓ The display will read **00_4**
- ✓ Press the **[ENTER/STORE]** key to save the entry to memory and increment to the next address **01_F**
- ✓ Enter the remaining numbers in their respective addresses as shown below:

4	8	4	7	1	6	1	F	F	F	F	F	F	F	F	F
00	01	02	03	04	05	06	07	08	09	10	11	12	13	14	15

Valid entries for both the primary and secondary phone numbers are 0 - F with the numeric digits as dialed numbers and the alpha digits (A - F) representing the following functions:

- A = * on a Touchtone phone keypad
- B = # on a Touchtone phone keypad
- C = look for secondary dial tone for up to two seconds, then dial anyway
- D = three second pause
- E = five second pause
- F = end of phone number (F must be entered)

Primary Number Communication Format (16)

One location is needed to select the Communication Format to the primary phone number. Address 16 is used for this purpose. The default (factory setting) for this address is **16_A**, which is 4+2 Standard, 1800 Hz 'Carrier', 2300 Hz 'ack'. The user may enter 0, 1, 2, 4, 6, 8, C or E in place of the default, then press the [ENTER/STORE] key. Choose from the list of formats below:

- 0: 4+1 Ademco Express Standard, DTMF, 1400/2300 ACK
- 1: 4+2 Ademco Express Standard, DTMF, 1400/2300 ACK
- 2: 3+1 Standard 1800 Hz Carrier, 2300 Hz ACK
- 3: Not used
- 4: 3+1 Standard 1900 Hz Carrier, 1400 Hz ACK
- 5: Not used
- 6: 4+1 Standard 1800 Hz Carrier, 2300 Hz ACK
- 7: Not used
- 8: 4+1 Standard 1900 Hz Carrier, 1400 Hz ACK
- 9: Not used
- A: 4+2 Standard 1800 Hz Carrier, 2300 Hz ACK
- B: Not used
- C: 4+2 Standard 1900 Hz Carrier, 1400 Hz ACK
- D: Not used
- E: Ademco Contact ID
- F: Not used

Note: Consult the Central Station for proper selection or consult the factory representatives. For any format chosen, the UDACT-F automatically programs all of the event codes. Refer to Table 3-2 on page 34, Table 3-3 on page 35, Table 3-4 on page 36, Table 3-5 on page 37, Table 3-6 on page 38 and Table 3-7 on page 39.

Primary Number Account Code (17-20)

The Account Code if provided by the Central Station. Four locations at addresses 17 - 20 which default to all '0s' must be changed to the supplied Account Code. Valid entries are 0 - 9 and A - F. The number of digits entered must match the format selection. If programming '2' or '4' into address 16, enter the three digit code (location 20 is ignored). If programming '0, 1, 6, 8, A, C or E' into address 16, enter the four digit code.

Primary Number 24 Hour Test Time (21-24)

Use military time when entering the 24 hour 'test' time. The 24 hour test report to phone number 1 takes up four locations (addresses 21 - 24). The default is 00:00 (12:00 midnight). The limits for each location are as follows:

- 21 = 0 to 2
- 22 = 0 to 9
- 23 = 0 to 5
- 24 = 0 to 9

Do not use 'A - F' as entries in these addresses.

Primary Number 24/12 Hour Test Time Interval (25)

The test report sent to the primary phone number may be sent every 12 or 24 hours. If the message is to be sent every 24 hours, leave the factory default entry of '0'. If a 12 hour test report time is needed, enter '1' for 12 hours.

Secondary Phone Number (26-41)

The sixteen addresses are factory set to 'F' (from **26_F** to **41_F**). Programming is typically done as follows:

- ✓ If the phone number to be entered is 484-7161, press **4**
- ✓ The display will read **26_4**
- ✓ Press the [ENTER/STORE] key to save the entry to memory and increment to the next address **27_F**

- ✓ Enter the remaining numbers in their respective addresses as shown below:

4	8	4	7	1	6	1	F	F	F	F	F	F	F	F	F
26	27	28	29	30	31	32	33	34	35	36	37	38	39	40	41

Valid entries for both the primary and secondary phone numbers are 0 - F with the numeric digits as dialed numbers and the alpha digits (A - F) representing the following functions:

- A = * on a Touchtone phone keypad
- B = # on a Touchtone phone keypad
- C = look for secondary dial tone for up to two seconds, then dial anyway
- D = three second pause
- E = five second pause
- F = end of phone number (F must be entered)

Secondary Number Communication Format (42)

One location is needed to select the Communication Format to the secondary phone number. Address 42 is used for this purpose. The default (factory setting) for this address is **42_A**, which is 4+2 Standard, 1800 Hz 'Carrier', 2300 Hz 'ack'. The user may enter 0, 1, 2, 4, 6, 8, C or E in place of the default, then press the **[ENTER/STORE]** key. Choose from the list of formats below:

- 0: 4+1 Ademco Express Standard, DTMF, 1400/2300 ACK
- 1: 4+2 Ademco Express Standard, DTMF, 1400/2300 ACK
- 2: 3+1 Standard 1800 Hz Carrier, 2300 Hz ACK
- 3: Not used
- 4: 3+1 Standard 1900 Hz Carrier, 1400 Hz ACK
- 5: Not used
- 6: 4+1 Standard 1800 Hz Carrier, 2300 Hz ACK
- 7: Not used
- 8: 4+1 Standard 1900 Hz Carrier, 1400 Hz ACK
- 9: Not used
- A: 4+2 Standard 1800 Hz Carrier, 2300 Hz ACK
- B: Not used
- C: 4+2 Standard 1900 Hz Carrier, 1400 Hz ACK
- D: Not used
- E: Ademco Contact ID
- F: Not used

Note: Consult the Central Station for proper selection or consult the factory representatives. For any format chosen, the UDACT-F automatically programs all of the event codes. Refer to Table 3-2 on page 34, Table 3-3 on page 35, Table 3-4 on page 36, Table 3-5 on page 37, Table 3-6 on page 38 and Table 3-7 on page 39.

Secondary Number Account Code (43-46)

Four locations at addresses 43 - 46 default to all '0s'. Valid entries are 0 - 9 and A - F. The number of digits entered must match the format selection. If programming '2' or '4' into address 42, enter three digits (location 46 is ignored). If programming '0, 1, 6, 8, A, C or E' into address 42, enter four digits.

Secondary Number 24 Hour Test Time (47-50)

Use military time when entering the 24 hour 'test' time. The 24 hour test report to phone number 2 takes up four locations (addresses 47 - 50). The default is 00:00 (12:00 midnight). The limits for each location are as follows:

- 47 = 0 to 2
- 48 = 0 to 9
- 49 = 0 to 5
- 50 = 0 to 9

Do not use 'A - F' as entries in these addresses.

Secondary Number 24/12 Hour Test Time Interval (51)

The test report sent to the secondary phone number may be sent every 12 or 24 hours. If the message is to be sent every 24 hours, leave the factory default entry of '0'. If a 12 hour test report time is needed, enter '1' for 12 hours.

Start Monitoring Address (52-53)

The entries in these addresses indicate the first group of zones or points to be monitored and reported to the Central Station. The factory default entry is '01'. The only valid entry is '01' (S2000 or MS-9200) or '20' (MS-9600). Refer to Table 3-1 .

End Monitoring Address (54-55)

The entries in these addresses indicate the last group of zones or points to be monitored and reported to the Central Station. The factory default entry is '01'. Valid entries are '01' and '04' (S2000 or MS-9200) or '20' to '32' (MS-9600). Refer to Table 3-1 .

Note that the Start and End Monitoring Address programming locations are used to set the reporting range of the UDACT-F.

TABLE 3-1: Start and End Monitoring Address

Zone Reporting (factory default)			Point Reporting		
	START Address 52-53	END Address 54-55		START Address 52-53	END Address 54-55
MS-9200	01 ¹	01	MS-9200	01 ¹	04 ¹
MS-9600	20 ²	32	MS-9600	20 ²	32 ²
S2000	01 ³	01	S2000	N/A	N/A
1 = Report status of 56 software zones 2 = Report status of 99 software zones 3 = Report status of 56 zones			1 = Report status of 198 points 2 = Report status of 636 points		

Note: For additional information on the starting and ending addresses, refer to the host FACP Technical Manual.

UDACT-F Communication Selection (56)

Leaving address 56 at '0' disables communications to the Central Station(s). Enter '1' for zone reporting receive only, '2' for zone reporting receive/transmit, '3' for consecutive point reporting receive only, '4' for consecutive point reporting receive/transmit, '5' for code wheel matching point reporting receive only or '6' for code wheel matching point reporting receive/transmit. Refer to "Type Mode" on page 44 and "Point Reporting" on page 50 for additional information on code wheel match reporting.

Note: Use receive only selections when using remote annunciators. Be certain to set one of the annunciators for receive/transmit for EIA-485 communications bus supervision. Use the receive/transmit entries when annunciators are not installed or when the UDACT-F receive/transmit function is to be used to supervise the EIA-485 communication bus. For additional information on the receive/transmit function, refer to the specific annunciator technical manuals.

Backup Reporting (57)

Leaving address 57 at '0' means that reports will be transmitted to the secondary phone number only if attempts to communicate to the primary phone number are unsuccessful. Programming a '1' causes all reports to be transmitted to the secondary phone number.

Touchtone/Rotary Select (58)

A '0' programmed in this address by the factory triggers Touchtone dialing over both phone lines. Enter '1' for rotary dialing.

Make/Break Ratio (59)

An entry must be made in this address only if address 58 is set to '1'. Address 59 is factory set to '0' which is a 67/33 ratio, but may be changed to '1' which is 62/38 ratio.

Address (60)

Leave factory default of '0'.

Address (61)

Leave factory default of '0'.

AC Loss Reporting Delay (62)

The factory default entry of '1' causes a 6 hour time delay for AC loss reporting. A '0' entry causes immediate reporting of AC loss. Valid entries are '0 to 9' and 'A to F' corresponding to the following reporting delay times:

1 = 6 hours	9 = 17 hours
2 = 7 hours	A = 18 hours
3 = 8 hours	B = 19 hours
4 = 9 hours	C = 20 hours
5 = 10 hours	D = 21 hours
6 = 11 hours	E = 22 hours
7 = 15 hours	F = 23 hours
8 = 16 hours	

Host Panel ID (63)

Enter one of the following digits corresponding to the control panel in which the UDACT-F is installed. *A correct entry is essential for proper operation.*

0 = MS-9200	5 = MS-9600
1 = Do not use	6 = Do not use
2 = Sensiscan 2000	7 = Do not use
3 = Do not use	8 = Do not use
4 = Do not use	9 = Do not use

Loop Number (64-65)

This address is used for Contact ID format only. The factory default setting is '00'. Refer to "Reporting Formats" on page 47.

Sensor Number (66-68)

This address is used for Contact ID format only. The factory default setting is '000'. Refer to "Reporting Formats" on page 47.

Programming Event Codes (69-208)

The type of reports and 'event codes' that are sent to the Central Station are referenced in *Table 3-2 on page 34, Table 3-3 on page 35, Table 3-4 on page 36, Table 3-5 on page 37, Table 3-6 on page 38 and Table 3-7 on page 39*. The selections made for the Primary Central Station Number communication Format (address 16) and the Secondary Central Station Number Communication Format (address 42) automatically program addresses 69-208 with factory default selections.

Any of the event codes may be changed. *Consult the Central Station prior to altering the event codes*. For the 3+1, 4+1 and 4+1 Express formats, entering an event code of '0' will cause the communicator to NOT transmit the report. Enter '00' for 4+2 and 4+2 Express formats to NOT transmit the report. For Ademco Contact ID format, enter '000'. Transmission of reports to *either or both* Central Station phone numbers may be disabled.

Note the special 'System Abnormal Test Report' event code. This report was added per UL DACT requirements. This report is generated in place of the normal test report when an alarm and/or trouble condition exists at the time the test report is due to be sent.

Programming the Real-Time Clock

Entering an address greater than 209 will cause a display of the current time. On initial power-up, the clock will start running from the factory setting of 00:01 (military time). The far left digit will be flashing, indicating that this is the first digit to be programmed.

Hours and Minutes

To set the hour, select a digit then press the **[ENTER/STORE]** key. The digit 2nd from the left will start flashing. Select a digit then press the **[ENTER/STORE]** key. The hours setting is completed. With the digit 2nd from the right flashing, select a digit for the minutes then press the **[ENTER/STORE]** key. The digit on the far right will start flashing. Select a digit then press the **[ENTER/STORE]** key. The minutes setting is completed.

End Programming

Exit Programming Mode by pressing the **MODE** key, followed by the 4-digit code corresponding to an alternate mode of operation, then press the **[ENTER/STORE]** key. During Program Mode, if no key is pressed within 10 minutes, the UDACT-F will revert to Normal Mode.

3+1, 4+1 Express and 4+1 Standard Formats

If '0, 2, 4, 6 or 8' is entered for address 16, the following data is automatically programmed for the Primary Phone number event codes. Enter a '0' for the data setting to disable the report.

TABLE 3-2: Primary Number Event Codes - 3+1, 4+1 Express and 4+1 Standard

<u>Address</u>	<u>Description</u>	<u>Setting</u>
69	Primary # General Alarm Code	1
70	Primary # Zone/Point Alarm Code	0
71	Primary # General Supervisory Code	8
72	Primary # Zone/Point Supervisory Code	0
73	Primary # General Fault Code	F
74	Primary # AC Fault Code	F
75	Primary # Zone/Point Fault Code	0
76	Primary # Low Battery Fault Code	F
77	Primary # Telco Primary Line Fault Code	F
78	Primary # Telco Secondary Line Fault Code	F
79	Primary # NAC Fault Code	F
80	Primary # Communication Trouble Primary # Code	F
81	Primary # Communication Trouble Secondary # Code	F
82	Primary # 485 Communication Trouble Code	F
83	Primary # System Off Normal Code	F
84	Primary # UDACT-F Off Normal Code	F
85	Primary # General Alarm Restore Code	E
86	Primary # Zone/Point Alarm Restore Code	0
87	Primary # General Supervisory Restore Code	E
88	Primary # Zone/Point Supervisory Restore Code	0
89	Primary # General Fault Restore Code	E
90	Primary # AC Fault Restore Code	E
91	Primary # Zone/Point Fault Restore Code	0
92	Primary # Low Battery Fault Restore Code	E
93	Primary # Telco Primary Line Fault Restore Code	E
94	Primary # Telco Secondary Line Fault Restore Code	E
95	Primary # NAC Fault Restore Code	E
96	Primary # Communication Trouble Primary Number Restore Code	E
97	Primary # Communication Trouble Secondary Number Restore Code	E
98	Primary # 485 Communication Trouble Restore Code	E
99	Primary # System Off Normal Restore Code	E
100	Primary # UDACT-F Off Normal Restore Code	E
101	Primary # System 24 Hour Test	9
102	Primary # System 24 Hour Test with Active Event	F
103	Primary # Manual Test	9

Note: Zero entries prevent the transmission of the report to the Central Station

4+2 Standard and 4+2 Express Formats

If '1, A or C' is entered for address 16, the following data is automatically programmed for the Primary Phone number event codes. Enter a '0' for the data setting to disable the report.

TABLE 3-3: Primary Number Event Codes - 4+2 Standard and 4+2 Express

<u>Address</u>	<u>Description</u>	<u>Setting</u>
69 - 70	Primary # General Alarm Code	11
71 - 72	Primary # Zone/Point Alarm Code	00
73 - 74	Primary # General Supervisory Code	81
75 - 76	Primary # Zone/Point Supervisory Code	00
77 - 78	Primary # General Fault Code	F1
79 - 80	Primary # AC Fault Code	F6
81 - 82	Primary # Zone/Point Fault Code	00
83 - 84	Primary # Low Battery Fault Code	F8
85 - 86	Primary # Telco Primary Line Fault Code	FA
87 - 88	Primary # Telco Secondary Line Fault Code	FB
89 - 90	Primary # NAC Fault Code	FC
91 - 92	Primary # Communication Trouble Primary # Code	FD
93 - 94	Primary # Communication Trouble Secondary # Code	FE
95 - 96	Primary # 485 Communication Trouble Code	FE
97 - 98	Primary # System Off Normal Code	FF
99 - 100	Primary # UDACT-F Off Normal Code	FF
101 - 102	Primary # General Alarm Restore Code	E1
103 - 104	Primary # Zone/Point Alarm Restore Code	00
105 - 106	Primary # General Supervisory Restore Code	E2
107 - 108	Primary # Zone/Point Supervisory Restore Code	00
109 - 110	Primary # General Fault Restore Code	E3
111 - 112	Primary # AC Fault Restore Code	E6
113 - 114	Primary # Zone/Point Fault Restore Code	00
115 - 116	Primary # Low Battery Fault Restore Code	E8
117 - 118	Primary # Telco Primary Line Fault Restore Code	EA
119 - 120	Primary # Telco Secondary Line Fault Restore Code	EB
121 - 122	Primary # NAC Fault Restore Code	EC
123 - 124	Primary # Communication Trouble Primary Number Restore Code	ED
125 - 126	Primary # Communication Trouble Secondary Number Restore Code	EE
127 - 128	Primary # 485 Communication Trouble Restore Code	EE
129 - 130	Primary # System Off Normal Restore Code	EF
131 - 132	Primary # UDACT-F Off Normal Restore Code	EF
133 - 134	Primary # System 24 Hour Test	99
135 - 136	Primary # System 24 Hour Test with Active Event	91
137 - 138	Primary # Manual Test	92

Note: Zero entries prevent the transmission of the report to the Central Station

Ademco Contact ID Format

If 'E' is entered for address 16, the following data is automatically programmed for the Primary phone number event codes. Enter '000' for the data setting to disable the report.

TABLE 3-4: Ademco Contact ID Primary Number

Address	Description	Setting ¹	Sensor Number
69 - 71	Primary # General Alarm Code	110	000 ²
72 - 74	Primary # Zone/Point Alarm Code	110 ⁴	Note ³
75 - 77	Primary # General Supervisory Code	200	000 ²
78 - 80	Primary # Zone/Point Supervisory Code	200	Note ³
81 - 83	Primary # General Fault Code	300	
84 - 86	Primary # AC Fault Code	301	
87 - 89	Primary # Zone/Point Fault Code	380	Note ³
90 - 92	Primary # Low Battery Fault Code	302	
93 - 95	Primary # Telco Primary Line Fault Code	351	
96 - 98	Primary # Telco Secondary Line Fault Code	352	
99 - 101	Primary # NAC Fault Code	321	
102 - 104	Primary # Communication Trouble Primary # Code	354	
105 - 107	Primary # Communication Trouble Secondary # Code	354	
108 - 110	Primary # 485 Communication Trouble Code	300	
111 - 113	Primary # System Off Normal Code	308	
114 - 116	Primary # UDACT-D Off Normal Code	350	
117 - 119	Primary # System 24 Hour Test	602	
120 - 122	Primary # System 24 Hour Test with Active Event	608	
123 - 125	Primary # Manual Test Message	601	

Notes:

1. Zero entries prevent the transmission of the report to the Central Station
2. Refer to Contact ID program locations 64 - 68
3. The identification of the zone/sensor number is automatically transmitted by the UDACT-F and is added to the main event code. Refer to Table A-3, "Ademco Contact ID Reporting Structure," on page 49, for additional information
4. Factory default for this report is 110 (110 is transmitted for modules, however, 111 will automatically be transmitted for smoke detectors). Use Type Mode (refer to "Type Mode" on page 44) to change this report per zone or point

3+1, 4+1 Express and 4+1 Standard Formats

If '0, 2, 4, 6 or 8' is entered for address 42, the following data is automatically programmed for the Secondary Phone number event codes. Enter a '0' for the data setting to disable the report.

TABLE 3-5: Secondary Number Event Codes - 3+1, 4+1 Express and 4+1 Standard

<u>Address</u>	<u>Description</u>	<u>Setting</u>
139	Secondary # General Alarm Code	1
140	Secondary # Zone/Point Alarm Code	0
141	Secondary # General Supervisory Code	8
142	Secondary # Zone/Point Supervisory Code	0
143	Secondary # General Fault Code	F
144	Secondary # AC Fault Code	F
145	Secondary # Zone/Point Fault Code	0
146	Secondary # Low Battery Fault Code	F
147	Secondary # Telco Primary Line Fault Code	F
148	Secondary # Telco Secondary Line Fault Code	F
149	Secondary # NAC Fault Code	F
150	Secondary # Communication Trouble Primary # Code	F
151	Secondary # Communication Trouble Secondary # Code	F
152	Secondary # 485 Communication Trouble Code	F
153	Secondary # System Off Normal Code	F
154	Secondary # UDACT-F Off Normal Code	F
155	Secondary # General Alarm Restore Code	E
156	Secondary # Zone/Point Alarm Restore Code	0
157	Secondary # General Supervisory Restore Code	E
158	Secondary # Zone/Point Supervisory Restore Code	0
159	Secondary # General Fault Restore Code	E
160	Secondary # AC Fault Restore Code	E
161	Secondary # Zone/Point Fault Restore Code	0
162	Secondary # Low Battery Fault Restore Code	E
163	Secondary # Telco Primary Line Fault Restore Code	E
164	Secondary # Telco Secondary Line Fault Restore Code	E
165	Secondary # NAC Fault Restore Code	E
166	Secondary # Communication Trouble Primary Number Restore Code	E
167	Secondary # Communication Trouble Secondary Number Restore Code	E
168	Secondary # 485 Communication Trouble Restore Code	E
169	Secondary # System Off Normal Restore Code	E
170	Secondary # UDACT-F Off Normal Restore Code	E
171	Secondary # System 24 Hour Test	9
172	Secondary # System 24 Hour Test with Active Event	F
173	Secondary # Manual Test	9

Note: Zero entries prevent the transmission of the report to the Central Station

4+2 Standard and 4+2 Express Formats

If '1, A or C' is entered for address 42, the following data is automatically programmed for the Secondary Phone number event codes. Enter a '0' for the data setting to disable the report.

TABLE 3-6: Secondary Number Event Codes - 4+2 Standard and 4+2 Express

<u>Address</u>	<u>Description</u>	<u>Setting</u>
139 - 140	Secondary # General Alarm Code	11
141 - 142	Secondary # Zone/Point Alarm Code	00
143 - 144	Secondary # General Supervisory Code	81
145 - 146	Secondary # Zone/Point Supervisory Code	00
147 - 148	Secondary # General Fault Code	F1
149 - 150	Secondary # AC Fault Code	F6
151 - 152	Secondary # Zone/Point Fault Code	00
153 - 154	Secondary # Low Battery Fault Code	F8
155 - 156	Secondary # Telco Primary Line Fault Code	FA
157 - 158	Secondary # Telco Secondary Line Fault Code	FB
159 - 160	Secondary # NAC Fault Code	FC
161 - 162	Secondary # Communication Trouble Primary # Code	FD
163 - 164	Secondary # Communication Trouble Secondary # Code	FE
165 - 166	Secondary # 485 Communication Trouble Code	FE
167 - 168	Secondary # System Off Normal Code	FF
169 - 170	Secondary # UDACT-F Off Normal Code	FF
171 - 172	Secondary # General Alarm Restore Code	E1
173 - 174	Secondary # Zone/Point Alarm Restore Code	00
175 - 176	Secondary # General Supervisory Restore Code	E2
177 - 178	Secondary # Zone/Point Supervisory Restore Code	00
179 - 180	Secondary # General Fault Restore Code	E3
181 - 182	Secondary # AC Fault Restore Code	E6
183 - 184	Secondary # Zone/Point Fault Restore Code	00
185 - 186	Secondary # Low Battery Fault Restore Code	E8
187 - 188	Secondary # Telco Primary Line Fault Restore Code	EA
189 - 190	Secondary # Telco Secondary Line Fault Restore Code	EB
191 - 192	Secondary # NAC Fault Restore Code	EC
193 - 194	Secondary # Communication Trouble Primary Number Restore Code	ED
195 - 196	Secondary # Communication Trouble Secondary Number Restore Code	EE
197 - 198	Secondary # 485 Communication Trouble Restore Code	EE
199 - 200	Secondary # System Off Normal Restore Code	EF
201 - 202	Secondary # UDACT-F Off Normal Restore Code	EF
203 - 204	Secondary # System 24 Hour Test	99
205 - 206	Secondary # System 24 Hour Test with Active Event	91
207 - 208	Secondary # Manual Test	92

Note: Zero entries prevent the transmission of the report to the Central Station

Ademco Contact ID Format

If 'E' is entered for address 42, the following data is automatically programmed for the Secondary phone number event codes. Enter '000' for the data setting to disable the report.

TABLE 3-7: Ademco Contact ID Secondary Number

Address	Description	Setting ¹	Sensor Number
139 - 141	Secondary # General Alarm Code	110	000 ²
142 - 144	Secondary # Zone/Point Alarm Code	110 ⁴	Note ³
145 - 147	Secondary # General Supervisory Code	200	000 ²
148 - 150	Secondary # Zone/Point Supervisory Code	200	Note ³
151 - 153	Secondary # General Fault Code	300	
154 - 156	Secondary # AC Fault Code	301	
157 - 159	Secondary # Zone/Point Fault Code	380	Note ³
160 - 162	Secondary # Low Battery Fault Code	302	
163 - 165	Secondary # Telco Primary Line Fault Code	351	
166 - 168	Secondary # Telco Secondary Line Fault Code	352	
169 - 171	Secondary # NAC Fault Code	321	
172 - 174	Secondary # Communication Trouble Primary # Code	354	
175 - 177	Secondary # Communication Trouble Secondary # Code	354	
178 - 180	Secondary # 485 Communication Trouble Code	300	
181 - 183	Secondary # System Off Normal Code	308	
184 - 186	Secondary # UDACT-D Off Normal Code	350	
187 - 189	Secondary # System 24 Hour Test	602	
190 - 192	Secondary # System 24 Hour Test with Active Event	608	
193 - 195	Secondary # Manual Test Message	601	

Notes:

1. Zero entries prevent the transmission of the report to the Central Station
2. Refer to Contact ID program locations 64 - 68
3. The identification of the zone/sensor number is automatically transmitted by the UDACT-F and is added to the main event code. Refer to Table A-3, "Ademco Contact ID Reporting Structure," on page 49, for additional information
4. Factory default for this report is 110 (110 is transmitted for modules, however, 111 will automatically be transmitted for smoke detectors). Use Type Mode (refer to "Type Mode" on page 44) to change this report per zone or point

CHAPTER 4

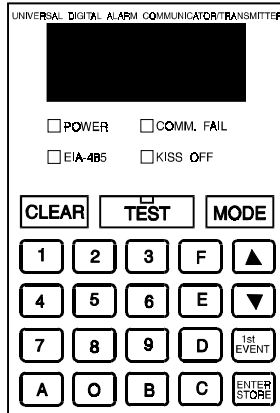
Operating Instructions

4.1 Normal Mode

The UDACT-F has five modes of operation:

- Normal Mode
- Type Mode
- Program Mode
- Lamp Test Mode
- Troubleshoot Mode

Upon initial power-up, the system will be in Normal Mode. This section describes the operation of the UDACT-F in the Normal Mode.

4.1.1 Keypad Functions

Clear

The Clear function will cause the UDACT-F to :

- cease transmissions
- clear any active or pending transmissions
- reset and return to normal system processing

To perform the Clear function, press the **CLEAR** key followed by **2532** and then press the **[ENTER/STORE]** key.

☛ **2532** spells CLEA on a Touch-Tone® phone.

Test

If the **TEST** key is pressed three times in rapid succession, the UDACT-F will transmit a test message to both Central Stations. The message reported is the same as the automatic test message for all formats except Ademco Contact ID.

Mode

Pressing the **MODE** key followed by a valid 4-digit numerical code and pressing the **[ENTER/STORE]** key selects one of the five modes of operation. To enter Normal Mode from any other mode, press the **MODE** key followed by **6676** and then the **[ENTER/STORE]** key.

☛ **6676** spells NORM on a Touch-Tone® phone.

1st Event

The 1st Event key along with the up arrow and down arrow keys are used to display UDACT-F fault conditions. Press the 1st Event key at any time to display the first event that occurred.

Down Arrow

The down arrow key can be used to view UDACT-F fault events (older) that have occurred and are active (not cleared).

Up Arrow

The up arrow key can be used to view UDACT-F fault events (newer) that have occurred and are active (not cleared).

[Enter/Store]

See individual mode descriptions in the following sections.

4.1.2 Displays

Four 7-segment red LED characters provide visual annunciation of UDACT-F trouble conditions. A list of messages that may appear on the display in Normal Mode is shown below:

PH_1	Primary Number Communication Fault
PH_2	Secondary Number Communication Fault
no_1	Primary Phone Line Fault
no_2	Secondary Phone Line Fault

Individual LEDs are provided for:

EIA-485

A yellow LED that turns on steady when a fault on the EIA-485 circuit is detected.

Comm. Fail

This yellow LED turns on to indicate the loss of both telephone lines or that the maximum number of attempts to communicate with both Central Stations had been unsuccessful. *During a comm. fail, the display will show either a PH1 and PH2 or no1 and no2.*

Power On

A green LED that remains on while DC power is supplied to the UDACT-F. *If this indicator fails to light under normal conditions, service the system immediately.*

Kissoff

A green LED that blinks when the Central Station has acknowledged receipt of each transmitted message.

Test

A green LED that turns on to indicate that a manual test message is being transmitted.

Primary Line Active

A red LED that indicates the primary phone line is active

Secondary Line Active

A red LED that indicates the secondary phone line is active.

Modem

A green LED that stays on steady during modem types of communications.

FIGURE 4-1: UDACT-F Phone Connectors and LEDs

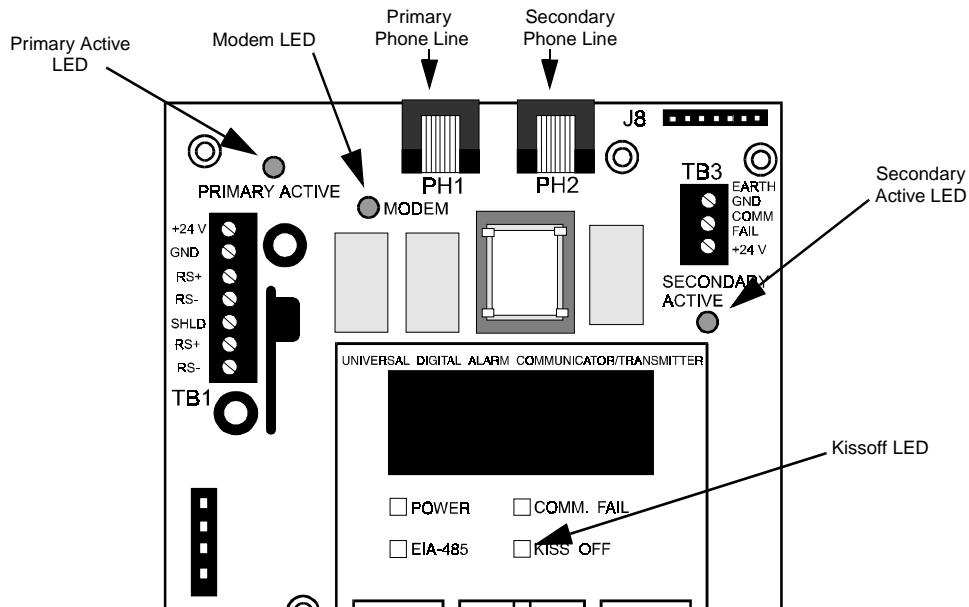

4.1.3 Normal Mode Operation

Normal Mode is the standard mode of operation. In this mode, the UDACT-F monitors host FACP status, power input, EIA-485 communications and telephone line voltage. The four character 7-segment display is normally off and does not annunciate events that are being transmitted. The display will only annunciate UDACT-F trouble conditions in the Normal Mode.

The UDACT-F transmits zone/point and system status reports to a Central Station via the public switched telephone network. Two supervised telephone line connections are made to interface the UDACT-F to the telephone lines.

The UDACT-F supervises both telephone lines for proper voltage. A delay of two minutes will occur before a fault in either phone line connection is reported as a trouble. When a fault is detected, the four character display will show either 'no1' for a Primary Line fault or 'no2' for a Secondary Line fault and the trouble condition will be reported to the Central Station over the remaining good phone line.

The UDACT-F comes with line seizure capability provided for both the primary and secondary telephone line interfaces. *Any time that the UDACT-F needs to make a call to the Central Station, line seizure will disconnect any local premises phones sharing the same telephone line.*

All transmissions to the Central Station will be sent over the Primary phone line. In the event of noisy phone lines, transmissions will be sent over the backup Secondary phone line.

Two phone numbers must be programmed, the Primary phone number and the Secondary phone number. All system reports will be transmitted to the primary phone number. Reports will automatically be sent to the secondary phone number if attempts to transmit to the primary phone number are unsuccessful. If 10 total attempts to communicate are unsuccessful, the Communicator Failure output will be turned on (TB3, Terminal 2). Note that as an option, *all* reports may also be sent to the secondary phone number. Refer to "Programming Instructions" on page 27.

The UDACT-F meets NFPA 72 for Remote Station Protective Signaling Service and Central Station Signaling Service reporting requirements for:

- the type of signal
- condition
- location of the reporting premises

Since higher priority events take precedence over lower priority events, the UDACT-F will transmit higher priority events before sending the lower priority events. Priorities are as follows:

Event Activations

1. General Alarm
2. Zone/Point Alarm #N
3. General Supervisory
4. Zone/Point Supervisory #N
5. General System Trouble
6. AC Power Loss
7. Zone/Point Trouble #N
8. Low Battery
9. Telco Primary Line Fault
10. Telco Secondary Line Fault
11. NAC Fault Code
12. Communication Trouble, Primary Number
13. Communication Trouble, Secondary Number
14. EIA-485 Communication Bus Trouble
15. System Off Normal Code
16. System Automatic Test Report
17. System Abnormal Automatic Test Report
18. Manual Activated Test Report

Event Restorals

19. General Alarm Restoral
20. Zone/Point Alarm #N Restoral
21. General Supervisory Restoral
22. Zone/Point Supervisory #N Restoral
23. General System Trouble Restoral
24. AC Power Loss Restoral
25. Zone/Point Trouble #N Restoral
26. Low Battery Restoral
27. Telco Primary Line Fault Restoral
28. Telco Secondary Line Fault Restoral
29. NAC Fault Code Restoral
30. Communication Trouble, Primary Number Restoral
31. Communication Trouble, Secondary Number Restoral
32. EIA-485 Communication Bus Trouble Restoral
33. System Off Normal Code Restoral

Note: #N represents the number of zones or devices in alarm or trouble. This is valid for all formats except Ademco Contact ID.

For all formats, the 'general' reports are always transmitted (unless disabled). The zone or point information may follow the general report if enabled.

For all pulsed formats and both Ademco Express formats, the zone/point report is repeated per the total number of zones or points activated once factory default entries of zero are removed. See Table 3-2 on page 34, Table 3-3 on page 35, Table 3-4 on page 36, Table 3-5 on page 37, Table 3-6 on page 38 and Table 3-7 on page 39. When Ademco Contact ID format is used, the actual zone or point activated is identified in the report.

The UDACT-F is supplied factory programmed with the reports identified above as item numbers 2, 4, 7, 20, 22 and 25 set to zero, preventing the reports from being transmitted for the pulsed and Ademco Express formats. These reports are factory programmed for active transmission when using the Ademco Contact ID.

4.1.4 Key Report Descriptions

UDACT-F Off Normal Report

Removing the UDACT-F from Normal Mode and placing it into Program or Troubleshoot Mode causes the transmission of a 'UDACT-F Off Normal' fault message. Returning the UDACT-F to Normal Mode causes a transmission of a 'UDACT-F Return to Normal' restoral message.

Panel Off Normal Report

The UDACT-F will report a 'System Off Normal' report when the host FACP temporarily shuts down the EIA-485 communications bus during various aspects of system programming or during Walktesting. When the host FACP is returned to normal, restoring the fire protection, the UDACT-F will report a 'System Off Normal Restoral' report.

System Test Report

The UDACT-F will transmit a test message to both Central Stations at programmed intervals (typically every 24 hours). Should there exist an abnormal condition in the fire alarm system (such as an alarm, trouble or supervisory condition) at the time when the test report is due to be transmitted, the UDACT-F will report the 'System Abnormal Test Report'. If the system is normal, the report transmitted will be the normal 'System Test Report'.

EIA-485 Communications Trouble Report

The UDACT-F supervises the integrity of the information received from the FACP via the EIA-485 communications bus. Should the communications bus malfunction, the UDACT-F transmits the report '485 Comm Trouble'. When the communications bus returns to proper operation, the UDACT-F will report '485 Comm Trouble Restoral'.

4.2 Type Mode

Type Mode may be used to disable reports by zone or point and to identify the specific functionality of each zone or point in the system. Factory default for all zones/points is Fire Alarm. Use Type Mode to identify the function of each zone or point as follows:

- General Fire Alarm
- Supervisory
- Pull Stations
- Heat Detectors
- Waterflows
- Duct Detectors
- Flame Sensor
- Smoke Zone

To access Type Mode, press the **MODE** key followed by the 4-digit code **8973** and then press the **[ENTER/STORE]** key. The UDACT-F will display three digits. For example, initial entry will display **01 0**.

The characters to the left identify the zone or point number. In the preceding example, 01 identifies zone 01 or point address 01. The character to the right (0 in this example) identifies the type of zone or point as defined in the following:

- 0 = Zone or point defined as fire alarm
 - 1 = Disable zone or point report
 - 2 = Zone or point defined as supervisory
 - 3 = Zone or point defined as pull station
 - 4 = Zone or point defined as heat detector
 - 5 = Zone or point defined as waterflow
 - 6 = Zone or point defined as duct detector
 - 7 = Zone or point defined as flame sensor
 - 8 = Zone or point defined as smoke zone
- (Use MMF-302 modules monitoring conventional smoke detectors. In point reporting, addressable detectors automatically report as detectors eliminating the need for Type Mode entry).

Factory default is all zones or points set to '0' for fire alarm. Zone reporting allows the mixing of types of devices on a single zone. To change the type definition of the zone or point from the factory default, select '2' to '8' corresponding to the type of device(s) used (do not mix device types for these settings), or select '1' to disable alarm reporting of any zone or point. The digit entered will appear on the far right display. Next, press the [ENTER/STORE] key. This stores the entry into E² memory and increments to the next higher address.

Use the **Up arrow**, **Down arrow** and **1st Event** keys to move through the list of zones or points (refer to Appendices D and E), similar to the method described in the programming section of this manual. For MS-9200 applications, when address 56 is programmed as a '3' or '4' for point reporting, detectors are reported as points 001 to 099 and modules are reported as points 101 to 199. When address 56 is programmed as a '5' or '6' for code wheel matching point reporting, detectors and modules report as 001 - 099 (the actual device address).

To define all zones or points as fire alarm (return to original factory default settings), enter zone or point 999 and then press the [ENTER/STORE] key. The display will change to **01 0**, indicating a return to the factory default settings.

4.2.1 Disabling of Zones or Points

This feature is primarily used when system points have been defined as remote reset, acknowledge, silence or drill switches. Refer to the FACP technical manual for additional information. Activation of remote switches appear as alarms on the EIA-485 bus while in point type of annunciation. The UDACT-F will report these points as fire alarm points unless disabled in the Type Mode. Disabling zones or points also prohibits the activation (shorted or alarm activated condition) from being reported by the UDACT-F. Disabling of the zone or point does not affect the reporting of the zone or point trouble condition.

4.2.2 Zone or Point Supervisory

A zone or point must be defined as supervisory to allow the UDACT-F to identify the correct report to transmit to the Central Station. Follow the programming instructions in the FACP manual to program a zone or point as supervisory. Next program the zone or point as a code '2' for supervisory. Use the charts in the Appendices to enter point and zone definitions. *Note that the UDACT-F fire protection and reporting capabilities are inactive while in Type Mode.*

4.3 Troubleshoot Mode

To enter Troubleshoot Mode, press the **MODE** key. Enter the code **8768** and press the **[ENTER/STORE]** key.

☛ **8768** spells TROU on a Touch-Tone® phone.

Once in Troubleshoot Mode, the UDACT-F will:

- transmit the 'UDACT-F Off Normal' message to the Central Station(s)
- continue to communicate any events not yet acknowledged at the Central Station prior to entering Troubleshoot Mode

The **Up arrow**, **Down arrow** and **1st Event** keys do not function in this mode.

Telephone Line Testing

Pressing **C** for touchtone dialing or **D** for rotary dialing, followed by **[ENTER/STORE]** causes seizure of the Primary phone line, which in turn, lights the red LED signifying Primary phone line active. After a delay of three seconds, the UDACT-F goes off-hook to acquire a dial tone.

The UDACT-F keypad may be used as a telephone touchpad for number dialing. Once the first digit is pressed, the display will move the **C** or **D** character one position to the left, while placing the digit to be dialed on the farthest right display position. Continue to enter the phone numbers to be dialed. Successive depressions of the **[ENTER/STORE]** key hangs up and picks up the phone (places the phone on or off the hook).

The secondary phone line may be tested by pressing the **E** key for touchtone dialing or the **F** key for rotary dialing and then following the same procedure used for the primary phone line.

A handset may be temporarily connected across transformer T1 as indicated in Figure 4-2. The handset, when connected across T1, may be used only as an amplifier/speaker or telephone with the UDACT-F used for number dialing.

FIGURE 4-2: Handset/Speaker Connection

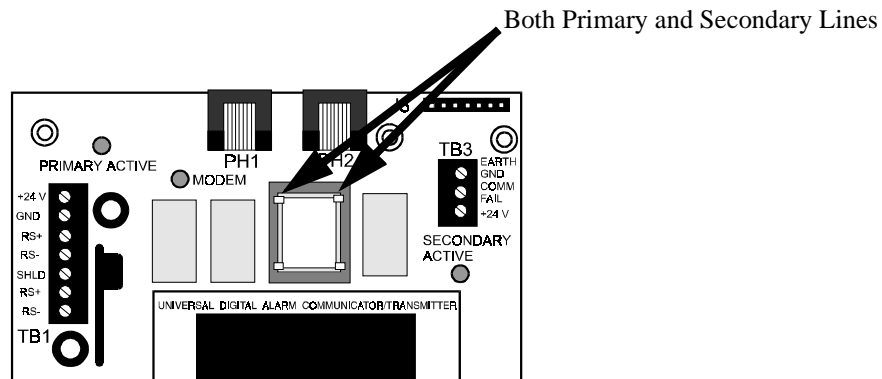

4.4 Lamp Test Mode

To perform a Lamp Test, press the **MODE** key and then enter the code **5267**. Next, press the **[ENTER/STORE]** key to test all system LEDs. The LEDs will stay on for five seconds, then the UDACT-F will return to Normal Mode.

☛ **5267** spells LAMP on a Touch-Tone® phone.

Appendix A *Reporting Formats*

Table A-1 shows the data reporting structure for each of the pulsed formats as well as the Ademco Express formats. Ademco Express formats allow a typical data message to be transmitted to the Central Station in under five seconds. Pulsed formats typically require 15 to 20 seconds in comparison. Table A-2 on page 48, defines each letter code used in Table A-1. Table A-3 on page 49, describes the data reporting structure used for Ademco Contact ID format.

TABLE A-1: Data Reporting Structure

Report	Format # 0, 2, 4, 6, 8	Format # 1, A, C
	3+1/4+1/Standard 4+1 Express	4+2/Standard 4+2 Express
Alarm	SSS(S) A	SSSS AA2
Alarm Restore	SSS(S) RA	SSSS RARA2
Zone Trouble (Zone Open)	SSS(S) RTZ	SSSS TZTZ2
Zone Trouble Restore	SSS(S) RTZ	SSSS RTZRTZ2
System Trouble	SSS(S) TS	SSSS TSTS2
System Trouble Restore	SSS(S) RTS	SSSS RTSRTS2
Low Battery	SSS(S) L	SSSS LL2
Low Battery Restore	SSS(S) RL	SSSS RLRL2
AC Loss	SSS(S) P	SSSS PP2
AC Loss Restore	SSS(S) RP	SSSS RPRP2
Supervisory Condition	SSS(S) V	SSSS VV2
Supervisory Condition Restore	SSS(S) RV	SSSS RVRV2
Test Report	SSS(S) X	SSSS XX2
Abnormal Test Report	SSS(S) XA	SSSS XAXA2

Notes:

Refer to Table A-2 on page 48, for an explanation of each letter code in Table A-1.

Refer to Table B-1 on page 51, for a list of compatible receivers.

TABLE A-2: Letter Code Definitions for Table A-1**Where:**

SSS or SSSS	=	Subscriber ID
A	=	Alarm (1st digit)
A2	=	Alarm (2nd digit)
RA	=	Alarm Restore (1st digit)
RA2	=	Alarm Restore (2nd digit)
TZ	=	Zone Trouble (1st digit)
TZ2	=	Zone Trouble (2nd digit)
RTZ	=	Zone Trouble Restore (1st digit)
RTZ2	=	Zone Trouble Restore (2nd digit)
TS	=	System Trouble (1st digit)
TS2	=	System Trouble (2nd digit)
RTS	=	System Trouble Restore (1st digit)
RTS2	=	System Trouble Restore (2nd digit)
L	=	Low Battery (1st digit)
L2	=	Low Battery (2nd digit)
RL	=	Low Battery Restore (1st digit)
RL2	=	Low Battery Restore (2nd digit)
P	=	AC Loss (1st digit)
P2	=	AC Loss (2nd digit)
RP	=	AC Loss Restore (1st digit)
RP2	=	AC Loss Restore (2nd digit)
V	=	Supervisory Condition (1st digit)
V2	=	Supervisory Condition (2nd digit)
RV	=	Supervisory Condition Restore (1st digit)
RV2	=	Supervisory Condition Restore (2nd digit)
X	=	Test Report (1st digit)
X2	=	Test Report (2nd digit)
XA	=	Abnormal Test Report (1st digit)
XA2	=	Abnormal Test Report (2nd digit)

The reporting structure for the Ademco Contact ID format is as follows:

TABLE A-3: Ademco Contact ID Reporting Structure

SSSS 18 QXYZ GG CCC

where

SSSS	=	Four digit Subscriber ID (addresses 17 - 20 and 43 - 46)
18	=	Identifies transmission of Contact ID to the receiver at the Central Station
Q	=	Event Qualifier E = New Event R = New Restore
XYZ	=	Event code (shown in Table 3-4 on page 36 and Table 3-7 on page 39)
GG	=	Group number or Loop number
CCC	=	Zone or Sensor number

For general reports (alarm, trouble and supervisory), the GG and CCC fields are transmitted as 00 and 000 unless changes to addresses 64 - 65 and 66 - 68 are made.

64 - 65 = Loop number (GG), factory default if 00

66 - 68 = Sensor number (CCC) for General Alarm, Fault or Supervisory messages - factory default is 000.

A typical printout of alarm and trouble reports in the Ademco Contact ID Reporting Structure follows:

Time	Date	Rcvr/Line ID	SSSS	QXYZ	GG	CCCC
11:28	03/25	11	7777	E110	00	CCCC - general alarm
11:28	03/25	11	7777	E110	00	C046 - alarm SD46
11:28	03/25	11	7777	E300	00	CCCC - general trouble
11:28	03/25	11	7777	E380	00	C046 - trouble SD46
11:28	03/25	11	7777	R110	00	CCCC - general alarm restore
11:28	03/25	11	7777	R110	00	C046 - alarm SD46 restore
11:28	03/25	11	7777	R300	00	CCCC - general trouble restore
11:28	03/25	11	7777	R380	00	C046 - trouble SD46 restore

Notes:

1. In the sample report, SD46 refers to smoke detector at address 46 or on zone 46. Refer to the charts on the following page as well as "Point Assignments - MS-9200" on page 56 and "Code Wheel Matching Point Assignments - MS-9200" on page 57, for further clarification
2. **18**, which is used in the reporting structure to identify the transmission as Contact ID, is not printed out in the alarm and trouble report
3. **Q**, which is the Event Qualifier for the reporting structure, is printed out in the report as an E for New Event or R for New Restore

Point Reporting

By using the Type Mode feature with address 56 set to 3, 4, 5 or 6, identification of each type of activated device is possible. Note that addressable detectors report as code 111. It should also be noted that the meaning of the first digit of the three digit zone/sensor number will depend on the Type Mode programmed in address 56 (i.e. Type 2, Device address 1 in the tables below, when 5 or 6 is programmed in address 56, C001 will be reported for both modules and detectors. When 3 or 4 is programmed in address 56, C101 will be reported for modules while C001 will be reported for detectors). Module points are programmable.

The following table provides examples of reporting structures for addressable modules.

TABLE A-4: Addressable Module Reporting Structure

Type ID#	Activated Device	Module Point	Report Address 56 = 5 or 6	Report Address 56 = 3 or 4
2	Supervisory Alarm	1	E200 00 C001	E200 00 C101
8	Smoke Zone Alarm ¹ (conventional)	2	E111 00 C002	E111 00 C102
3	Pull Station Alarm	3	E115 00 C003	E115 00 C103
4	Heat Sensor Alarm	4	E114 00 C004	E114 00 C104
5	Waterflow Alarm	5	E113 00 C005	E113 00 C105
6	Duct Detector Alarm ¹ (conventional)	6	E116 00 C006	E116 00 C106
7	Flame Sensor Alarm	7	E117 00 C007	E117 00 C107
..... through				
8	Smoke Zone Alarm ¹ (conventional)	99 or 159 ²	E111 00 C099 or E111 00 C159 ²	E111 00 C199 or E111 00 C259 ²

1. Use of M302 Monitor Module for conventional smoke and duct detectors
2. 99 relates to MS-9200; 159 and 259 relates to MS-9600

The following table provides an example of the reporting structure for addressable smoke detectors.

Type ID	Activated Device	Addressable Detector Point #	Report Address 56 = 3, 4, 5 or 6
Automatically set to smoke detector (8)	300 or 350 Series Detectors	001 to 099 or 159 ¹	E111 00 C001 to E111 00 C099 or E111 00 C159 ¹

1. 99 relates to MS-9200; 159 relates to MS-9600

Zone Reporting

By using the Type Mode feature with address 56 set to 1 or 2, identification of the function of each software zone is possible. The following table provides examples of zone reporting structures.

TABLE A-5: Zone Reporting Structure

Type ID #	Zone Function	Zone #	Report
8	Smoke Zone	1	E111 00 C001
5	Waterflow Zone	2	E113 00 C002
2	Supervisory Zone	3	E200 00 C003
3	Pull Stations	4	E115 00 C004
..... through			
5	Waterflow Zone	56 or 99 ¹	E113 00 C056 or E113 00 C099 ¹

1. 56 relates to MS-9200; 99 relates to MS-9600

Appendix B

Compatible Receivers

The chart below shows UL listed receivers compatible with the UDACT-F.

TABLE B-1: Compatible UL Listed Receivers

Format # (Addresses 16 & 42)		Ademco 685 (1)	Silent Knight 9000 (2)	ITI CS-4000 (3)	FBI CP220FB	Osborne Hoffmann Quick Alert Models 1 & 2	Radionics 6000/6500 (5)	Linear/Sescoa 3000R (7)	Surguard MLR-2 (9)
0	4+1 Ademco Express	✓			✓				✓
1	4+2 Ademco Express	✓			✓	✓(8)			✓
2	3+1/Standard/1800/2300	✓	✓	✓	✓(4)	✓	✓(5, 6)	✓	✓
3	Not Used								
4	3+1/Standard/1900/1400	✓	✓		✓(4)	✓		✓	✓
5	Not Used								
6	4+1/Standard/1800/2300	✓	✓	✓	✓(4)	✓	✓(5)	✓	✓
7	Not Used								
8	4+1/Standard/1900/1400	✓	✓		✓(4)	✓		✓	✓
9	Not Used								
A	4+2/Standard/1800/2300	✓	✓	✓	✓(4)	✓	✓(5)	✓	✓
B	Not Used								
C	4+2/Standard/1900/1400	✓	✓		✓(4)	✓		✓	✓
D	Not Used								
E	Ademco Contact ID	✓			✓	✓			✓
F	Not Used								

- (1) With 685-8 Line Card with Rev 4.4d software
- (2) With 9002 Line Card Rev 9035 software or 9032 Line Card with 9326A software
- (3) Rev. 4.0 software
- (4) FBI CP220FB Rec-11 Line Card with Rev 2.6 software and a memory card with Rev 3.8 software
- (5) Model 6500 with Rev 600 software
- (6) Model 6000 with Rev 204 software
- (7) With Rev B control card at Rev 1.4 software and Rev C line card at Rev 1.5 software
- (8) Model 2 only
- (9) Version 1.62 software

Appendix C *Programming Reference Sheets*

...To enter Programming Mode, press the **MODE** key, the code **7764** and then the **[ENTER/STORE]** key...

₀₀ ₀₁ ₀₂ ₀₃ ₀₄ ₀₅ ₀₆ ₀₇ ₀₈ ₀₉ ₁₀ ₁₁ ₁₂ ₁₃ ₁₄ ₁₅

Addresses 00 to 15 store the Primary Phone Number. Enter 'F' to represent the end of the number. Default all Fs

₁₆ Primary Communication Format: Enter 0 - F.

₁₇ ₁₈ ₁₉ ₂₀ Primary Account Code: Valid entries are '0 - F'. Default is '0000'.

₂₁ ₂₂ ₂₃ ₂₄ Primary 24-Hour Test Time. Enter military time (i.e. 1400 for 2 PM).

₂₅ Primary Number Test Time Interval. Enter default '0' for 24 hr.; '1' for 12 hr.

₂₆ ₂₇ ₂₈ ₂₉ ₃₀ ₃₁ ₃₂ ₃₃ ₃₄ ₃₅ ₃₆ ₃₇ ₃₈ ₃₉ ₄₀ ₄₁

Addresses 26 to 41 store the Secondary Phone Number. Enter 'F' to represent the end of the number. Default all Fs

₄₂ Secondary Communication Format: Enter 0 - F.

₄₃ ₄₄ ₄₅ ₄₆ Secondary Account Code: Valid entries are '0 - F'.

₄₇ ₄₈ ₄₉ ₅₀ Secondary 24-Hour Test Time. Enter military time (i.e. 1400 for 2 PM).

₅₁ Secondary Number Test Time Interval. Enter default '0' for 24 hr.; '1' for 12 hr.

₅₂ ₅₃ Start Monitoring Address.

₅₄ ₅₅ End Monitoring Address.

₅₆ UDACT-F Communication Selection. Enter '0' to disable UDACT-F communication; '1' for zone reporting receive only communication; '2' for zone reporting receive/transmit communication; '3' for point reporting receive only communication; '4' for point reporting receive/transmit communication; '5' for code wheel matching reporting, receive only; '6' for code wheel matching point reporting, receive/transmit.

₅₇ Backup Reporting. Enter '0' to have secondary phone number act as backup only; '1' to have secondary phone number receive all reports and messages along with primary phone number.

₅₈ Touchtone/Rotary Select. Enter '0' for touchtone dialing; '1' for rotary dialing.

₅₉ Make/Break Ratio. If rotary dialing is selected in Address 58; enter '0' for a 67/73 make/break ratio; '1' for a 62/38 make/break ratio.

₆₀ Leave default of '0'.

₆₁ Leave default of '0'













































































































































₆₂ AC Loss Delay. Enter '0' for no time delay after AC loss; '1' for 6 hours; '2' for 7 hours; '3' for 8 hours; '4' for 9 hours; '5' for 10 hours; '6' for 11 hours; '7' for 15 hours; '8' for 16 hours; '9' for 17 hours; 'A' for 18 hours; 'B' for 19 hours; 'C' for 20 hours; 'D' for 21 hours; 'E' for 22 hours; 'F' for 23 hours. Default is '0'.

₆₃ Host Panel ID. Enter '0' for MS-9200; '2' for Sensiscan 2000; '5' for MS-9600; all other entries are invalid.

₆₄ ₆₅ Loop Number for General Reports. Factory set to '00'.

₆₆ ₆₇ ₆₈ Sensor Number for General Reports. Factory set to '000'.

Programming Reference Sheets

 69	 70	 71	 72	 73	 74	 75	 76	 77	 78	 79	 80	 81
 82	 83	 84	 85	 86	 87	 88	 89	 90	 91	 92	 93	 94
 95	 96	 97	 98	 99	 100	 101	 102	 103	 104	 105	 106	 107
 108	 109	 110	 111	 112	 113	 114	 115	 116	 117	 118	 119	 120
 121	 122	 123	 124	 125	 126	 127	 128	 129	 130	 131	 132	 133
 134	 135	 136	 137	 138	 139	 140	 141	 142	 143	 144	 145	 146
 147	 148	 149	 150	 151	 152	 153	 154	 155	 156	 157	 158	 159
 160	 161	 162	 163	 164	 165	 166	 167	 168	 169	 170	 171	 172
 173	 174	 175	 176	 177	 178	 179	 180	 181	 182	 183	 184	 185
 186	 187	 188	 189	 190	 191	 192	 193	 194	 195	 196	 197	 198
 199	 200	 201	 202	 203	 204	 205	 206	 207	 208			

Programming Reference Sheet Factory Default Settings

...To enter Programming Mode, press the **MODE** key, the code **7764** and then the **[ENTER/STORE]** key...

F₀₀ **F**₀₁ **F**₀₂ **F**₀₃ **F**₀₄ **F**₀₅ **F**₀₆ **F**₀₇ **F**₀₈ **F**₀₉ **F**₁₀ **F**₁₁ **F**₁₂ **F**₁₃ **F**₁₄ **F**₁₅

Addresses 00 to 15 store the Primary Phone Number. *Enter 'F' to represent the end of the number.*

A₁₆ Primary Communication Format: *(4+2 Standard, 1800/2300).*

0₁₇ **0**₁₈ **0**₁₉ **0**₂₀ Primary Account Code:

0₂₁ **0**₂₂ **0**₂₃ **0**₂₄ Primary 24-Hour Test Time. *0000 = 12:00 midnight.*

0₂₅ Primary Number Test Time Interval. *'0' for 24 hr.*

F₂₆ **F**₂₇ **F**₂₈ **F**₂₉ **F**₃₀ **F**₃₁ **F**₃₂ **F**₃₃ **F**₃₄ **F**₃₅ **F**₃₆ **F**₃₇ **F**₃₈ **F**₃₉ **F**₄₀ **F**₄₁

Addresses 26 to 41 store the Secondary Phone Number. *Enter 'F' to represent the end of the number.*

A₄₂ Secondary Communication Format: *(4+2 Standard, 1800/2300)*

0₄₃ **0**₄₄ **0**₄₅ **0**₄₆ Secondary Account Code:

0₄₇ **0**₄₈ **0**₄₉ **0**₅₀ Secondary 24-Hour Test Time. *0000 = 12:00 midnight.*

0₅₁ Secondary Number Test Time Interval. *'0' for 24 hr.*

0₅₂ **1**₅₃ Start Monitoring Address.

0₅₄ **1**₅₅ End Monitoring Address.

0₅₆ UDACT-F Communication Selection. *'0' to disable UDACT-F communication.*

0₅₇ Backup Reporting. *'0' to have secondary phone number act as backup only.*

0₅₈ Touchtone/Rotary Select. *'0' for touchtone dialing.*

0₅₉ Make/Break Ratio. *'0' for a 67/73 make/break ratio.*

0₆₀ Leave default of '0'.

0₆₁ Leave default of '0'

1₆₂ AC Loss Delay. *'1' for 6 hour delay.*

0₆₃ Host Panel ID. *'0' for MS-9200.*

0₆₄ **0**₆₅ Loop Number. *For Ademco Contact ID, only loop number = '00'.*

0₆₆ **0**₆₇ **0**₆₈ Sensor Number. *For Ademco Contact ID, only sensor number = '000'.*

Programming Reference Sheet Factory Default

1₆₉ **1**₇₀ **0**₇₁ **0**₇₂ **8**₇₃ **1**₇₄ **0**₇₅ **0**₇₆ **F**₇₇ **1**₇₈ **F**₇₉ **6**₈₀ **0**₈₁
0₈₂ **F**₈₃ **8**₈₄ **F**₈₅ **A**₈₆ **F**₈₇ **B**₈₈ **F**₈₉ **C**₉₀ **F**₉₁ **D**₉₂ **F**₉₃ **E**₉₄
F₉₅ **E**₉₆ **F**₉₇ **F**₉₈ **F**₉₉ **F**₁₀₀ **E**₁₀₁ **1**₁₀₂ **0**₁₀₃ **0**₁₀₄ **E**₁₀₅ **2**₁₀₆ **0**₁₀₇
0₁₀₈ **E**₁₀₉ **3**₁₁₀ **E**₁₁₁ **6**₁₁₂ **0**₁₁₃ **0**₁₁₄ **E**₁₁₅ **8**₁₁₆ **E**₁₁₇ **A**₁₁₈ **E**₁₁₉ **B**₁₂₀
E₁₂₁ **C**₁₂₂ **E**₁₂₃ **D**₁₂₄ **E**₁₂₅ **E**₁₂₆ **E**₁₂₇ **E**₁₂₈ **E**₁₂₉ **F**₁₃₀ **E**₁₃₁ **F**₁₃₂ **9**₁₃₃
9₁₃₄ **9**₁₃₅ **1**₁₃₆ **9**₁₃₇ **2**₁₃₈ **1**₁₃₉ **1**₁₄₀ **0**₁₄₁ **0**₁₄₂ **8**₁₄₃ **1**₁₄₄ **0**₁₄₅ **0**₁₄₆
F₁₄₇ **1**₁₄₈ **F**₁₄₉ **6**₁₅₀ **0**₁₅₁ **0**₁₅₂ **F**₁₅₃ **8**₁₅₄ **F**₁₅₅ **A**₁₅₆ **F**₁₅₇ **B**₁₅₈ **F**₁₅₉
C₁₆₀ **F**₁₆₁ **D**₁₆₂ **F**₁₆₃ **E**₁₆₄ **F**₁₆₅ **E**₁₆₆ **F**₁₆₇ **F**₁₆₈ **F**₁₆₉ **F**₁₇₀ **E**₁₇₁ **1**₁₇₂
0₁₇₃ **0**₁₇₄ **E**₁₇₅ **2**₁₇₆ **0**₁₇₇ **0**₁₇₈ **E**₁₇₉ **3**₁₈₀ **E**₁₈₁ **6**₁₈₂ **0**₁₈₃ **0**₁₈₄ **E**₁₈₅
8₁₈₆ **E**₁₈₇ **A**₁₈₈ **E**₁₈₉ **B**₁₉₀ **E**₁₉₁ **C**₁₉₂ **E**₁₉₃ **D**₁₉₄ **E**₁₉₅ **E**₁₉₆ **E**₁₉₇ **E**₁₉₈
E₁₉₉ **F**₂₀₀ **E**₂₀₁ **F**₂₀₂ **9**₂₀₃ **9**₂₀₄ **9**₂₀₅ **1**₂₀₆ **9**₂₀₇ **2**₂₀₈

Appendix D *Point Assignments - MS-9200*

(Program Address 56 = 3 or 4)

Use chart to carefully identify all points in the system. Leading zero (0) in point number signifies detectors and leading one (1) signifies modules. Take special precaution with any supervisory points and remote switches in the system. Use Type Mode to match the function of remaining points in the system for proper reporting (see "Type Mode" on page 44).

Point	Type of Device: (Detectors)	Point	Type of Device: (Detectors)	Point	Type of Device: (Modules)	Point	Type of Device: (Modules)
001		051		101		151	
002		052		102		152	
003		053		103		153	
004		054		104		154	
005		055		105		155	
006		056		106		156	
007		057		107		157	
008		058		108		158	
009		059		109		159	
010		060		110		160	
011		061		111		161	
012		062		112		162	
013		063		113		163	
014		064		114		164	
015		065		115		165	
016		066		116		166	
017		067		117		167	
018		068		118		168	
019		069		119		169	
020		070		120		170	
021		071		121		171	
022		072		122		172	
023		073		123		173	
024		074		124		174	
025		075		125		175	
026		076		126		176	
027		077		127		177	
028		078		128		178	
029		079		129		179	
030		080		130		180	
031		081		131		181	
032		082		132		182	
033		083		133		183	
034		084		134		184	
035		085		135		185	
036		086		136		186	
037		087		137		187	
038		088		138		188	
039		089		139		189	
040		090		140		190	
041		091		141		191	
042		092		142		192	
043		093		143		193	
044		094		144		194	
045		095		145		195	
046		096		146		196	
047		097		147		197	
048		098		148		198	
049		099		149		199	
050				150			

Appendix E *Code Wheel Matching Point Assignments - MS-9200*

(Program Address 56 = 5 or 6)

Use chart to carefully identify all points in the system. Take special precaution with any supervisory points and remote switches in the system. Use Type Mode to match the function of remaining points in the system for proper reporting (see "Type Mode" on page 44).

Point	Type of Device: (Detectors)	Point	Type of Device: (Detectors)	Point	Type of Device: (Modules)	Point	Type of Device: (Modules)
001		051		001		051	
002		052		002		052	
003		053		003		053	
004		054		004		054	
005		055		005		055	
006		056		006		056	
007		057		007		057	
008		058		008		058	
009		059		009		059	
010		060		010		060	
011		061		011		061	
012		062		012		062	
013		063		013		063	
014		064		014		064	
015		065		015		065	
016		066		016		066	
017		067		017		067	
018		068		018		068	
019		069		019		069	
020		070		020		070	
021		071		021		071	
022		072		022		072	
023		073		023		073	
024		074		024		074	
025		075		025		075	
026		076		026		076	
027		077		027		077	
028		078		028		078	
029		079		029		079	
030		080		030		080	
031		081		031		081	
032		082		032		082	
033		083		033		083	
034		084		034		084	
035		085		035		085	
036		086		036		086	
037		087		037		087	
038		088		038		088	
039		089		039		089	
040		090		040		090	
041		091		041		091	
042		092		042		092	
043		093		043		093	
044		094		044		094	
045		095		045		095	
046		096		046		096	
047		097		047		097	
048		098		048		098	
049		099		049		099	
050				050			

Appendix F *Point Assignments - MS-9600* (Program Address 56 = 3 or 4)

F.1 Type Mode Programming

To disable or identify a zone or point in Type Mode (refer to “Type Mode” on page 44), the following Entries/Addresses are used:

F.1.1 For Zone Identification:

Zones 1 - 99 are programmed by Entries/Addresses 01 - 99. The factory default code is 'fire alarm' (see “Zone Assignments” on page 64).

F.1.2 For Point Identification:

Loop 1, Modules 1 - 64 are programmed by Type Mode Entries/Addresses 001 - 064
Loop 2, Modules 1 - 64 are programmed by Type Mode Entries/Addresses 065 - 128
Loop 1, Modules 65 - 128 are programmed by Type Mode Entries/Addresses 129 - 192
Loop 2, Modules 65 - 128 are programmed by Type Mode Entries/Addresses 193 - 256
Loop 1, Modules 129 - 159 are programmed by Type Mode Entries/Addresses 257 - 287 (288 not used)
Loop 2, Modules 129 - 159 are programmed by Type Mode Entries/Addresses 289 - 319 (320 not used)
Loop 1, Detectors 1 - 64 are programmed by Type Mode Entries/Addresses 321 - 384
Loop 2, Detectors 1 - 64 are programmed by Type Mode Entries/Addresses 385 - 448
Loop 1, Detectors 65 - 128 are programmed by Type Mode Entries/Addresses 449 - 512
Loop 2, Detectors 65 - 128 are programmed by Type Mode Entries/Addresses 513 - 576

F.2 Event Code/Report Transmission

Via Ademco Contact ID Format Only

F.2.1 For Zone Reporting:

Zones 1 - 99 report as zone numbers 01 - 99 (see “Zone Assignments” on page 64).

F.2.2 For Point Reporting:

Loop 1, Modules 1 - 64 report as device numbers 001 - 064
Loop 2, Modules 1 - 64 report as device numbers 065 - 128
Loop 1, Modules 65 - 128 report as device numbers 129 - 192
Loop 2, Modules 65 - 128 report as device numbers 193 - 256
Loop 1, Modules 129 - 159 report as device numbers 257 - 287 (288 is not used)
Loop 2, Modules 129 - 159 report as device numbers 289 - 319 (320 is not used)
Loop 1, Detectors 1 - 64 report as device numbers 321 - 384
Loop 2, Detectors 1 - 64 report as device numbers 385 - 448
Loop 1, Detectors 65 - 128 report as device numbers 449 - 512
Loop 2, Detectors 65 - 128 report as device numbers 513 - 576
Loop 1, Detectors 129 - 159 report as device numbers 577 - 607 (608 is not used)
Loop 2, Detectors 129 - 159 report as device numbers 609 - 639 (640 is not used)

F.3 Point Assignments

Use chart to carefully identify all points in the system. Take special precaution with any supervisory or non-fire points and remote switches in the system. Use Type Mode to match the function of remaining points in the system for proper reporting (see "Type Mode" on page 44).

Point	Type of Device: Module Loop 1	Point	Type of Device: Module Loop 1	Point	Type of Device: Module Loop 2	Point	Type of Device: Module Loop 2
001		033		065		097	
002		034		066		098	
003		035		067		099	
004		036		068		100	
005		037		069		101	
006		038		070		102	
007		039		071		103	
008		040		072		104	
009		041		073		105	
010		042		074		106	
011		043		075		107	
012		044		076		108	
013		045		077		109	
014		046		078		110	
015		047		079		111	
016		048		080		112	
017		049		081		113	
018		050		082		114	
019		051		083		115	
020		052		084		116	
021		053		085		117	
022		054		086		118	
023		055		087		119	
024		056		088		120	
025		057		089		121	
026		058		090		122	
027		059		091		123	
028		060		092		124	
029		061		093		125	
030		062		094		126	
031		063		095		127	
032		064		096		128	

Continued on the next page...

Point Assignments continued:

Point	Type of Device: Module Loop 1	Point	Type of Device: Module Loop 1	Point	Type of Device: Module Loop 2	Point	Type of Device: Module Loop 2
129		161		193		225	
130		162		194		226	
131		163		195		227	
132		164		196		228	
133		165		197		229	
134		166		198		230	
135		167		199		231	
136		168		200		232	
137		169		201		233	
138		170		202		234	
139		171		203		235	
140		172		204		236	
141		173		205		237	
142		174		206		238	
143		175		207		239	
144		176		208		240	
145		177		209		241	
146		178		210		242	
147		179		211		243	
148		180		212		244	
149		181		213		245	
150		182		214		246	
151		183		215		247	
152		184		216		248	
153		185		217		249	
154		186		218		250	
155		187		219		251	
156		188		220		252	
157		189		221		253	
158		190		222		254	
159		191		223		255	
160		192		224		256	

Continued on the next page...

Point Assignments continued:

Point	Type of Device: Module Loop 1	Point	Type of Device: Module Loop 2	Point	Type of Device: Detector Loop1	Point	Type of Device: Detector Loop 1
257		289		321		353	
258		290		322		354	
259		291		323		355	
260		292		324		356	
261		293		325		357	
262		294		326		358	
263		295		327		359	
264		296		328		360	
265		297		329		361	
266		298		330		362	
267		299		331		363	
268		300		332		364	
269		301		333		365	
270		302		334		366	
271		303		335		367	
272		304		336		368	
273		305		337		369	
274		306		338		370	
275		307		339		371	
276		308		340		372	
277		309		341		373	
278		310		342		374	
279		311		343		375	
280		312		344		376	
281		313		345		377	
282		314		346		378	
283		315		347		379	
284		316		348		380	
285		317		349		381	
286		318		350		382	
287		319		351		383	
288	Not Used	320	Not Used	352		384	

Note: Addressable detectors on Loops 1 and 2 may be disabled using Type Mode. The Event Code cannot be altered.

Continued on the next page...

Point Assignments continued:

Point	Type of Device: Detector Loop 2	Point	Type of Device: Detector Loop 2	Point	Type of Device: Detector Loop1	Point	Type of Device: Detector Loop 1
385		417		449		481	
386		418		450		482	
387		419		451		483	
388		420		452		484	
389		421		453		485	
390		422		454		486	
391		423		455		487	
392		424		456		488	
393		425		457		489	
394		426		458		490	
395		427		459		491	
396		428		460		492	
397		429		461		493	
398		430		462		494	
399		431		463		495	
400		432		464		496	
401		433		465		497	
402		434		466		498	
403		435		467		499	
404		436		468		500	
405		437		469		501	
406		438		470		502	
407		439		471		503	
408		440		472		504	
409		441		473		505	
410		442		474		506	
411		443		475		507	
412		444		476		508	
413		445		477		509	
414		446		478		510	
415		447		479		511	
416		448		480		512	

Note: Addressable detectors on Loops 1 and 2 may be disabled using Type Mode. The Event Code cannot be altered.

Continued on the next page...

Point Assignments continued:

Point No	Type of Device: Detector Loop 2	Point No	Type of Device: Detector Loop 2	Point No	Type of Device: Detector Loop1	Point No	Type of Device: Detector Loop 2
513		545		577		609	
514		546		578		610	
515		547		579		611	
516		548		580		612	
517		549		581		613	
518		550		582		614	
519		551		583		615	
520		552		584		616	
521		553		585		617	
522		554		586		618	
523		555		587		619	
524		556		588		620	
525		557		589		621	
526		558		590		622	
527		559		591		623	
528		560		592		624	
529		561		593		625	
530		562		594		626	
531		563		595		627	
532		564		596		628	
533		565		597		629	
534		566		598		630	
535		567		599		631	
536		568		600		632	
537		569		601		633	
538		570		602		634	
539		571		603		635	
540		572		604		636	
541		573		605		637	
542		574		606		638	
543		575		607		639	
544		576		608	Not Used	640	Not Used

Note: Addressable detectors on Loops 1 and 2 may be disabled using Type Mode. The Event Code cannot be altered.

Appendix G *Zone Assignments*

Use chart to carefully identify all zones in the system. Take special precaution with any supervisory or non-fire zones in the system. Use Type Mode to match the function of remaining points in the system for proper reporting (see "Type Mode" on page 44).

Zone	Zone Function	Zone	Zone Function	Zone	Zone Function
01		34		67	
02		35		68	
03		36		69	
04		37		70	
05		38		71	
06		39		72	
07		40		73	
08		41		74	
09		42		75	
10		43		76	
11		44		77	
12		45		78	
13		46		79	
14		47		80	
15		48		81	
16		49		82	
17		50		83	
18		51		84	
19		52		85	
20		53		86	
21		54		87	
22		55		88	
23		56		89	
24		57		90	
25		58		91	
26		59		92	
27		60		93	
28		61		94	
29		62		95	
30		63		96	
31		64		97	
32		65		98	
33		66		99	



Limited Warranty

The manufacturer warrants its products to be free from defects in materials and workmanship for eighteen (18) months from the date of manufacture, under normal use and service. Products are date-stamped at time of manufacture. The sole and exclusive obligation of the manufacturer is to repair or replace, at its option, free of charge for parts and labor, any part which is defective in materials or workmanship under normal use and service. For products not under the manufacturer's date-stamp control, the warranty is eighteen (18) months from date of original purchase by the manufacturer's distributor unless the installation instructions or catalog sets forth a shorter period, in which case the shorter period shall apply. This warranty is void if the product is altered, repaired, or serviced by anyone other than the manufacturer or its authorized distributors, or if there is a failure to maintain the products and systems in which they operate in a proper and workable manner. In case of defect, secure a Return Material Authorization form from our customer service department. Return product, transportation prepaid, to the manufacturer.

This writing constitutes the only warranty made by this manufacturer with respect to its products. The manufacturer does not represent that its products will prevent any loss by fire or otherwise, or that its products will in all cases provide the protection for which they are installed or intended. Buyer acknowledges that the manufacturer is not an insurer and assumes no risk for loss or damages or the cost of any inconvenience, transportation, damage, misuse, abuse, accident, or similar incident.

THE MANUFACTURER GIVES NO WARRANTY, EXPRESSED OR IMPLIED, OF MERCHANTABILITY, FITNESS FOR ANY PARTICULAR PURPOSE, OR OTHERWISE WHICH EXTEND BEYOND THE DESCRIPTION ON THE FACE HEREOF. UNDER NO CIRCUMSTANCES SHALL THE MANUFACTURER BE LIABLE FOR ANY LOSS OF OR DAMAGE TO PROPERTY, DIRECT, INCIDENTAL, OR CONSEQUENTIAL, ARISING OUT OF THE USE OF, OR INABILITY TO USE THE MANUFACTURER'S PRODUCTS. FURTHERMORE, THE MANUFACTURER SHALL NOT BE LIABLE FOR ANY PERSONAL INJURY OR DEATH WHICH MAY ARISE IN THE COURSE OF, OR AS A RESULT OF, PERSONAL, COMMERCIAL, OR INDUSTRIAL USE OF ITS PRODUCTS.

This warranty replaces all previous warranties and is the only warranty made by the manufacturer. No increase or alteration, written or verbal, of the obligation of this warranty is authorized.



World Headquarters
One Fire-Lite Place, Northford, CT 06472-1653 USA
203-484-7161 • Fax 203-484-7118
www.firelite.com

